



United States
Department of
Agriculture

Forest Service

Rocky Mountain
Forest and Range
Experiment Station

Fort Collins,
Colorado 80526

General Technical
Report RM-245



Stream Channel Reference Sites: An Illustrated Guide to Field Technique

Cheryl C. Harrelson
C. L. Rawlins
John P. Potyondy

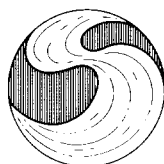

Harrelson, Cheryl C; Rawlins, C. L.; Potyondy, John P. 1994. Stream channel reference sites: an illustrated guide to field technique. Gen. Tech. Rep. RM-245. Fort Collins, CO: U.S. Department of Agriculture, Forest Service, Rocky Mountain Forest and Range Experiment Station. 61 p.

Abstract

This document is a guide to establishing permanent reference sites for gathering data about the physical characteristics of streams and rivers. The minimum procedure consists of the following: (1) select a site, (2) map the site and location, (3) measure the channel cross-section, (4) survey a longitudinal profile of the channel, (5) measure stream flow, (6) measure bed material, and (7) permanently file the information with the Vigil network. The document includes basic surveying techniques, provides guidelines for identifying bankfull indicators and measuring other important stream characteristics. The object is to establish the baseline of existing physical conditions for the stream channel. With this foundation, changes in the character of streams can be quantified for monitoring purposes or to support other management decisions.

Keywords: reference sites, stream channel monitoring, measurement techniques.



Prepared in support of the National Stream Systems Technology Center mission to enable land managers to "secure favorable conditions of water flows" from our National Forests.

Stream Channel Reference Sites: An Illustrated Guide to Field Technique

Cheryl C. Harrelson, Hydrologist¹
Bridger-Teton National Forest

C. L. Rawlins, Hydrology Technician²
Lincoln National Forest

John P. Potyondy, Hydrologist³
Rocky Mountain Forest and Range Experiment Station

¹ Cheryl C. Harrelson was a hydrologist on the Lincoln and Bridger-Teton National Forests. She has a B.S. in Watershed Science from Colorado State University.

² C. L. Rawlins was a hydrology technician on the Bridger-Teton National Forest and received the USDA Forest Service's National Primitive Skills Award in 1989. He has B.S. and M.S. degrees from Utah State and was a Stegner Fellow at Stanford University.

³ John P. Potyondy is a Hydrologist with the Rocky Mountain Forest and Range Experiment Station's Stream Systems Technology Center. He has B.S. and M.S. degrees from the University of Minnesota in Forestry. He has served as a Hydrologist at the Boise and Wasatch-Cache National Forests and at the Intermountain Region Regional Office.

Contents

1. Introduction	1
2. Selecting a Site	3
3. General Location Map	8
4. Drawing a Site Map	10
5. Surveying Basics	13
6. Measuring Channel Cross-Section	26
7. Floodplain and Bankfull Indicators	33
8. Longitudinal Profile Measurement	37
9. Installing a Staff Gage	42
10. Measuring Discharge	44
11. Bed and Bank Material Characterization	49
12. Permanent Files	53
References	55
Appendix A. Equipment List	56
Appendix B. Sample Vigil Site Record	57

Stream Channel Reference Sites: An Illustrated Guide to Field Technique

Cheryl C. Harrelson, C.L. Rawlins, and John P. Potyondy

1. Introduction

This document is a guide to establishing permanent reference sites for gathering data about streams and rivers. It presents techniques from a variety of published sources in a single, compact field manual. Use of these techniques will provide the sound, factual information needed to quantify the existing physical character of stream channels. The ability to accurately make and replicate stream channel measurements over a period of years and through changes in personnel is vital. To ensure the applicability of data collected with this manual, we consulted hydrologists in the Forest Service, U. S. Geological Survey, and private practice. We aimed to identify a set of basic procedures that will yield quality data without a high degree of specialization and at relatively low cost.

This manual is for entry-level hydrologists, biologists, and others directly responsible for managing streams and riparian areas. The focus is practical and specific. Field data was collected at one location to demonstrate these procedures and to serve as a consistent example throughout the manual.

OBJECTIVES

Natural systems have rhythms that can be difficult to describe. Some, like the seasonal rise and fall of water in a stream, can be measured simply. Others, like the lateral migration of channels across a floodplain, or changes in regional climate, may take decades or even lifetimes to occur. To accurately record such changes takes an extension of human memory through repeated measurement and scientific records.

Placing a permanent, benchmarked reference site is the first step in this long-term effort. Correctly done, it will support further work over time. The other elements are a monumented

cross-section, a longitudinal profile, a pebble count, and a discharge measurement. The object is to find the baseline of existing physical conditions for the stream channel. With this foundation of technically correct and comparable data, we can track changes in the character of the stream.

POTENTIAL USES OF DATA

Permanent reference site data is useful in many different contexts, supporting both local management decisions and broad research efforts. The baseline established is a foundation for a broad range of physical, chemical, and biological monitoring techniques. Potential uses for reference station data include

- monitoring trends in fluvial and geomorphic condition over time;
- quantifying environmental impact;
- assessing stream and watershed response to management;
- providing channel and flow facts for water allocation;
- supporting resource inventories (habitat, water quality, vegetation);
- tracking cumulative effects for entire drainage areas;
- allowing valid comparisons based on stream type; and
- contributing to regional, national, and international databases.

The techniques in this manual yield a basic, minimum set of physical data on streams. Users need to expand the amount of data collected to fit their specific needs. For example, if the object is to assess changes at one site over time, then collect the basic data set at regular intervals. If

the object is to compare pristine to disturbed watersheds, or to assess the response of different streams to management, then select several reaches of similar type.

A detailed study of channel response might survey multiple cross-sections to map riffles, pools, and meander bends. A study focused on habitat might collect further data on aquatic insects, plant communities, or groundwater. Regardless of the study's breadth or complexity, an accurate physical description of the stream is essential, along with consideration of statistical design in the planning of any data collection effort.

This guide covers the *minimum* needed to accurately characterize stream channels and

shows you the technically correct way to make those measurements.

The minimum procedure consists of the following:

1. Select a site.
2. Map the site and location.
3. Measure the channel cross section.
4. Survey a longitudinal profile of the channel.
5. Measure stream flow.
6. Measure bed material.
7. Permanently file the information.

2. Selecting a Site

Universal physical laws govern streams, yet every stream passes in a unique way through its landscape. Gravity and water are constants, so all streams tend toward a single ideal form; however, differences in location and physical conditions create the range of forms we see. Each stream balances erosion, transport, and deposition in the context of its climate and landscape.

We may classify stream channels in terms of eight major variables: width, depth, velocity, discharge, slope, roughness of bed and bank materials, sediment load, and sediment size (Leopold et al. 1964). Natural systems—streams in this case—are not random in their variation, but tend to cluster around the most likely combinations of variables based on physical and chemical laws rather than act randomly in their variation. This tendency to seek a probable balance of factors lends itself to classification.

When any of the factors controlling stream classification change, the others will adjust along with it toward a new, balanced state. Because change is continuous, so is the process of adjustment. In streams the strongest physical medium for adjustment is the flow of water. In adjusting, the stream will show measurable change along the continuum determined by this flow (Rosgen 1994).

A steep stream that enters a gentle valley will show a continuous change in several parameters from one state (cascades and stepped pools) to another (meanders, pools, and riffles). Sharp boundaries, such as Yosemite Falls, tend to be the exception rather than the rule. A distinct event—a tree falling into the stream, a landslide across the channel, or construction of a road—may drive the adjustment process in a new direction.

Understanding the process of change takes both accurate measurement and scientific interpretation. The permanent reference site establishes baseline conditions to provide an accurate basis for measuring change.

PLANNING

The process of deciding where to locate your reference site needs careful thought. Avoid the temptation to take your level, rod, waders, tapes,

and meters to the nearest stream. Planning provides greater assurance of success. The planning phase consists mostly of asking questions:

- What do we want to know about this stream or drainage?
- What variations (geology, elevation, land use) exist in the area?
- How can we set up the most useful comparisons with the fewest sites?
- How can this site contribute to existing or planned efforts?
- How much can be accomplished with present resources?

Before taking to the field, take to the files. Find out what has been done in your area. Often benchmarks, gages, or reference sites already exist. Other agencies such as the U.S. Geological Survey may have studies that can be expanded or extended for your purposes.

Document what has been done. Contact persons working in your area. Valuable studies may have been done by a local irrigation district or as part of a fisheries project. A day spent with files or in a library, or contacting others, may reward you with useful information.

Review sources on regional climate, geology, land types, vegetation, historic land uses, and forest plan guidelines. This overview can help you select good sites based on differences in watershed character. For example, if there are three major geologic types on your forest, you may want to locate a station within each of the types. Sites might be located to compare stream channel responses to management such as a stream in a roadless drainage against a similar one in a drainage with roads and timber harvest.

Planning guides your choice of site and helps to avoid mistakes like establishing a reference site in July on a stream exactly where a fish habitat construction project is planned for late August.

Planning should focus on efficient use of personnel, vehicles, and funds. Coordinating the establishment of field sites with other field work can lower costs.

STREAM CLASSIFICATION

Stream classification provides a way to look at stream channels, letting you group those that are similar or identify features that are different. Since we expect streams of similar type to act in similar ways, classification offers a powerful tool for selecting streams for comparison.

Of the various useful classifications that exist, the system developed by D.L. Rosgen is most commonly used by USDA Forest Service hydrologists.

Rosgen (1994) intends his classification to allow

- prediction of a river's behavior from its appearance;
- comparison of site-specific data from a given reach to data from other reaches of similar character; and
- a consistent and reproducible system of technical communication for river studies across a range of disciplines.

Rosgen's classification scheme initially sorts streams into the major, broad stream types (A-G) at a landscape level, as shown in figure 1. At this level, the system classifies streams from headwaters to lowlands with stream type:

- A — headwater
- B — intermediate
- C & E — meandering
- D — braided
- F — entrenched
- G — gully

The Rosgen system breaks stream types into subtypes based on slope ranges (fig. 2) and dominant channel material particle sizes (fig. 3). Subtypes are assigned numbers corresponding to the median particle diameter of channel materials:

- 1 = bedrock
- 2 = boulder
- 3 = cobble
- 4 = gravel
- 5 = sand
- 6 = silt/clay

This produces 41 major stream types. The above oversimplifies the Rosgen system, which includes additional parameters (see table 1, page 6). For more complete information about the classification and associated inventory procedures, see Rosgen (1994). Ultimately, stream classification helps to distinguish variations due to stream type from variations in the state or condition of sites.

Stream variables adjust continuously both through time and along the channel. Usually, one perfect stream type does not yield at a certain point to the next perfect type; the changes are continuous rather than sharply bounded. Recalling the stream continuum concept during classification helps resolve problems that arise when one parameter is outside the range for the stream type implied by the majority of parameters considered.

The decision that must be made at this point is whether to undertake a comprehensive inventory or to select a few representative watersheds. This depends on the concerns driving the data collection process. Long-term processes, such as a Forest Plan revision, an interagency monitoring effort, or an ecosystem management plan, require a deliberate approach to site selection and may include work over several years.

If, on the other hand, an immediate demand for information to support a court brief drives the process, the choice of sites and time may be strictly limited. Short-term measurement, if done to the proper standards, creates a potential

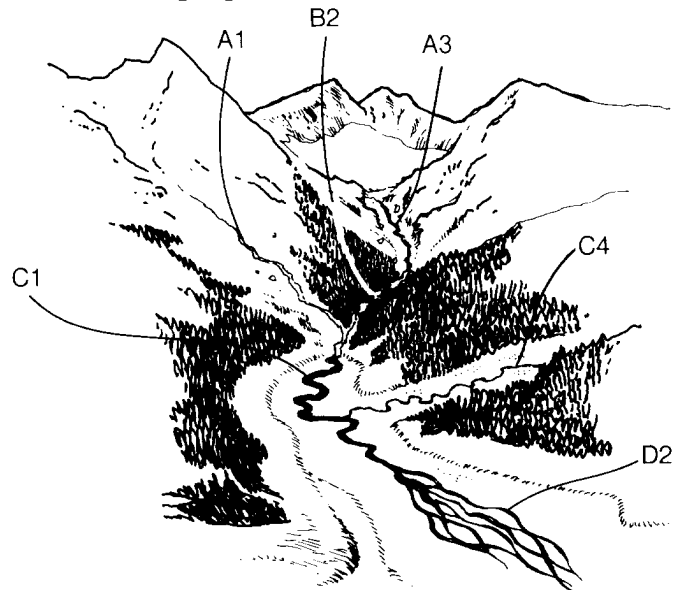

Figure 1. — Stream types in a mountain landscape (adapted from Rosgen 1984). Courtesy of David Rosgen, Wildland Hydrology Consultants.

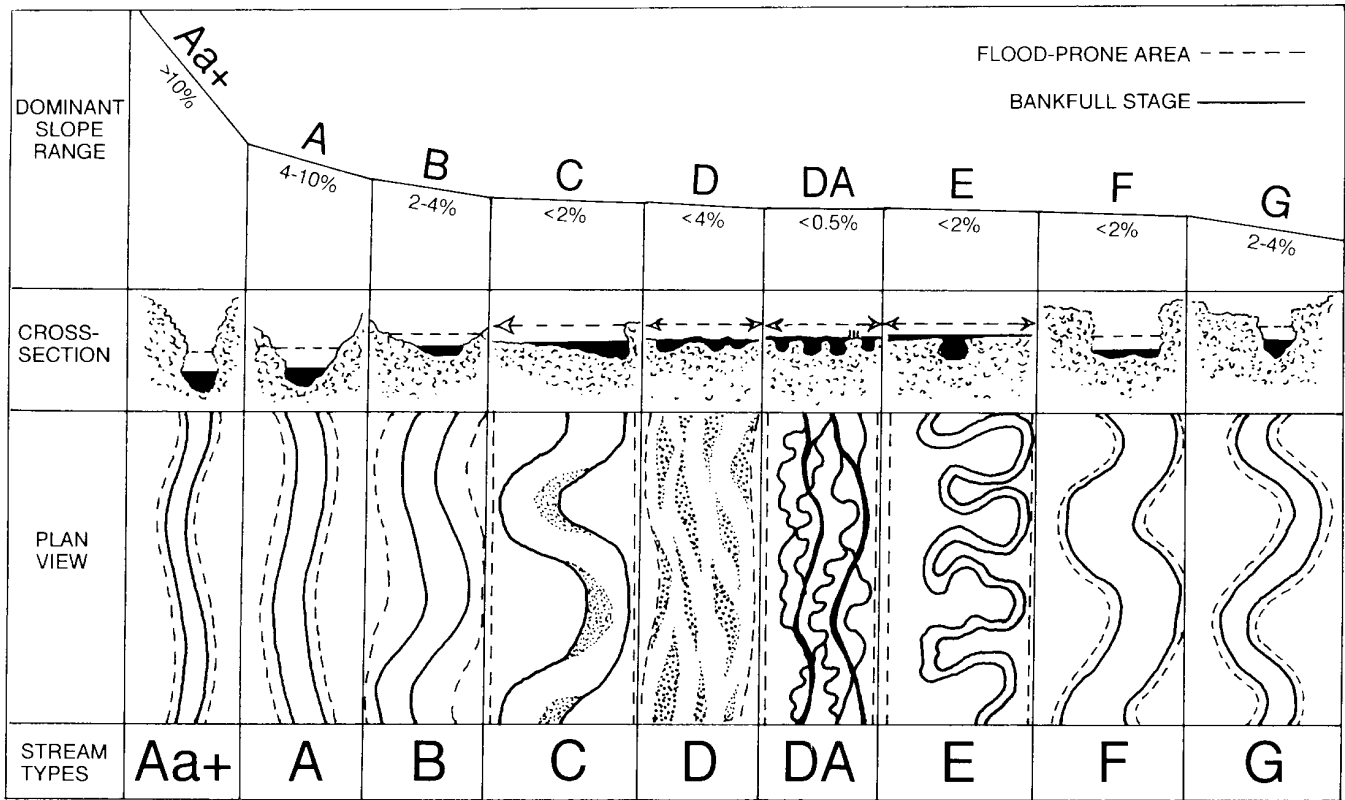

Figure 2. - Stream types: gradient, cross-section, plan view (adapted from Rosgen 1994). Original drawings by Lee Silvey. Courtesy of Catena Verlag.

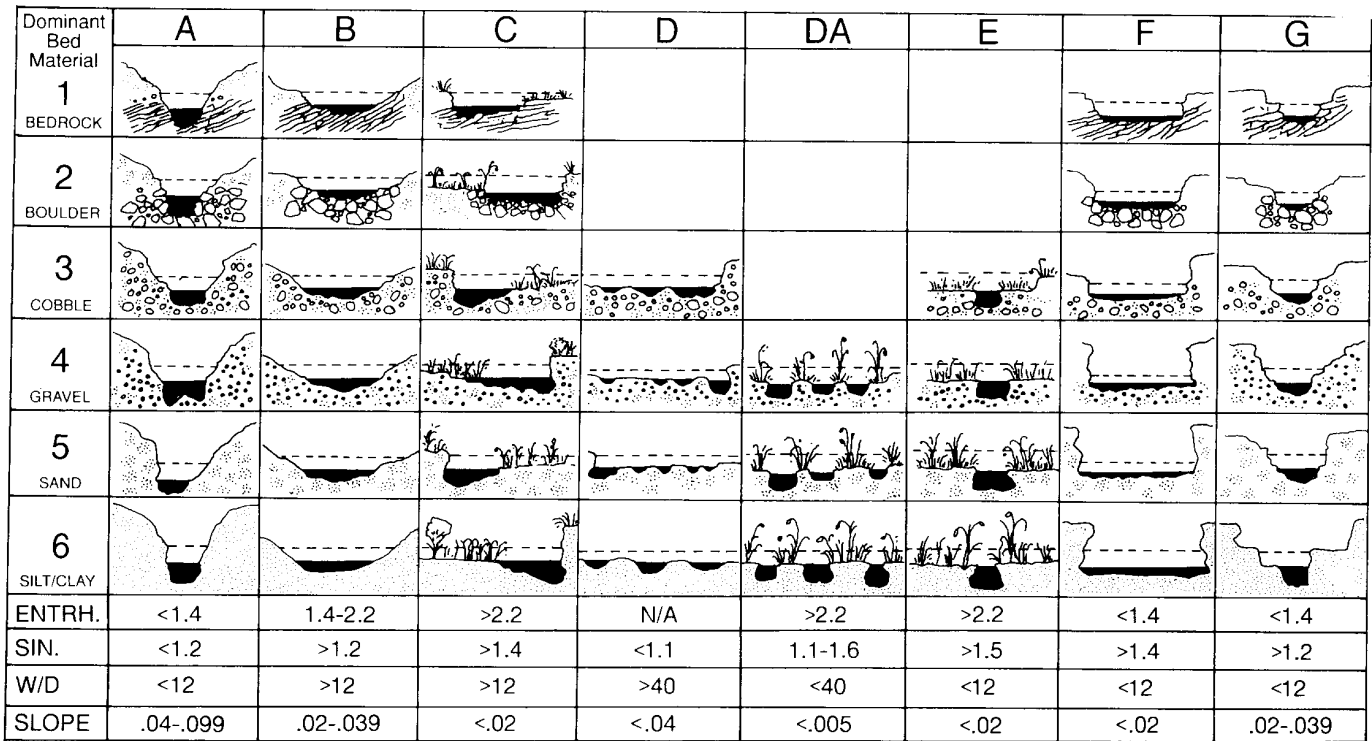

Figure 3. - Cross-section view of stream types (adapted from Rosgen 1994). Original drawings by Lee Silvey. Courtesy of Catena Verlag.

Table 1. – Summary of delineative criteria for broad level classification (adapted from Rosgen 1994). Courtesy of Catena Verlag.

Stream Type	General Description	Entrenchment Ratio	W/D Ratio	Sinuosity	Slope	Landform/Soils/Features
Aa+	Very steep, deeply entrenched, debris transport streams.	<1.4	<12	1.0 to 1.1	>0.10	Very high relief. Erosional, bedrock or depositional features; debris flow potential. Deeply entrenched. Vertical steps with deep scour pools and waterfalls.
A	Steep, entrenched, cascading step-pools. High-energy debris transport assoc. with depositional soils. Very stable if channel dominated by bedrock or boulders.	<1.4	<12	1.0 to 1.2	0.04 to 0.10	High relief. Erosional or depositional and bedrock forms. Entrenched and confined with cascading reaches. Frequently-spaced, deep pools in assoc. step-pool bed morphology.
B	Moderately entrenched, moderate-gradient, riffle-dominated channel with infrequently spaced pools. Very stable plan and profile. Stable banks.	1.4 to 2.2	>12	>1.2	0.02 to 0.039	Moderate relief, colluvial deposition and/or residual soils. Moderate entrenchment and W/D ratio. Narrow, gently sloping valleys. Rapids predominate with occasional pools.
C	Low-gradient, meandering, alluvial riffle-pool, channels with point-bars. Broad, well-defined floodplains.	>2.2	>12	<1.4	<0.02	Broad valleys with terraces in assoc. with floodplains alluvial soils. Slight entrenchment with well-defined meanders. Riffle/pool bed morphology.
D	Braided channel with longitudinal and transverse bars. Very wide channels with eroding banks.	n/a	>40	n/a	<0.04	Broad valleys with alluvial and colluvial fans. Glacial debris and depositional features. Active lateral adjustment with abundant sediment supply.
DA	Multiple channels, narrow and deep with expansive, vegetated floodplain and wetlands. Very gentle relief, highly variable sinuosity. Stable stream banks.	>4.0	<40	variable	<0.005	Broad, low-gradient valleys with fine alluvium and/or lacustrine soil. Multiple-channel geologic-control creating fine deposition with well-vegetated, laterally-stable bars. Broad floodplains and wetlands.
E	Low-gradient, meandering, riffle/pool stream with low W/D ratio and little deposition. Very efficient and stable. High meander width ratio.	>2.2	<12	>1.5	<0.02	Broad valley/meadows. Alluvial materials with floodplain. Highly sinuous with stable, well-vegetated banks. Riffle/pool morphology, very low W/D ratio.
F	Entrenched, meandering riffle/pool channel, of low gradient, with high width/depth ratio.	<1.4	<12	1.4	<0.02	Entrenched in highly weathered material. Low-gradient, with high W/D ratio. Meandering, laterally unstable with high bank erosion. Riffle/pool bed.
G	Entrenched, "gully" step-pool channel, on moderate gradients, with low width/depth ratio.	<1.4	<12	>1.2	0.02 to 0.039	Narrow valley, or deeply incised in alluvial or colluvial material (i.e., fans or deltas). Unstable, with grade control problems and high rates of bank erosion. Gully, step-pool bed.

for further collection of data. Thus, a short-term concern (such as a water-rights case) provides an opportunity to establish permanent reference sites that can be useful for many years in a variety of other contexts.

This long-term potential makes quality field work essential. A well-placed site, with accurate and fully documented measurements, has value extending far into the future. When the boulders are slick, and your waders leak, and

the mosquitoes form clouds around your head as you take survey notes, it helps to think of your work as part of a lasting legacy.

FINAL SITE SELECTION

Once a stream has been selected, locate a site for the monumented cross-section and longitudi-

nal survey in the field before starting your survey measurements.

The measurement techniques in this document apply to wadable streams. If your target stream is too high during peak runoff, you can still establish a benchmark, shoot elevations at the water's edge, and mark indicators of stream stage with pin-flags. Schedule the remainder of the field work for low-water periods.

For a general-purpose reference site, the best practice is to avoid sites with evident impacts and to fully document any factors on or near the site that influence stream character.

1. Choose sites with evident natural features. Features of most interest include those involved in developing and maintaining the channel, floodplains, terraces, bars, and natural vegetation.
2. Look for evidence of physical impact on the stream, banks, or in the floodplain from fords, roads, bridges, buildings, diversions, dams, habitat structures, etc. — unless your purpose includes studies of the effects of road encroachment, culverts, regulated flows (dams, diversions), heavy livestock use, and highly impacted watersheds (high road density, high levels of soil disturbance).
3. The reach should include an entire meander (*i.e.*, two bends) if possible. The length should be at least 20 times the bankfull width of the channel. Given the fairly constant relation between the width of the channel, the radii of meander bends, and the sequence of pools and riffles, this

length will include a range of features sufficient to accurately characterize the stream. Unless your purpose includes studies of beaver dams, debris jams, boulder fields, bedrock controls, and recently adjusted channels (flood, disturbance), select your site to avoid such features.

4. Locate the monumented cross-section on a straight segment between two bends. This is the best location for the repeated measurements of discharge needed to generate a rating curve.
5. Access should be *possible* with the necessary tools (level, rod, waders, etc.) yet not so easy that there are tire tracks and firepits all over the floodplain. Good locations are a compromise between the comfort of the hydrologist and the long-term integrity of the site. Use your *best* scientific instinct.

Placing of a complete reference site usually requires a full day, with a follow-up visit likely. Finishing calculations, plotting, and documenting the site generally require another day of office work.

The following sections of this manual describe field procedures in the logical progression of field work normally required to establish a permanent reference site. The first step in that process is mapping the location of the study site. The next two sections discuss mapping standards to permanently document the location of the site for future reference.

3. General Location Map

The general location map should consist of two items:

- 1) an existing map such as a U. S. Geological Survey 7 1/2' quad topographic map (1:24,000 scale), U. S. Forest Service 0.5" base series map, or other land status map (fig. 4) and
- 2) a sketch-map in the field book (fig. 5).

Use the existing map as a reference to locate the site or sites in the future. Permanently file the map. Cross-reference the sketch-map in the field book to the file map. The sketch map should include

- legal descriptions;
- direction arrows;
- bearings and distances from permanent, natural landmarks (artificial structures such as fences, houses, etc. may be altered or removed);
- road numbers (e.g., I-90, Wyoming 16, Sheridan County 125); and
- odometer readings where possible.

Alternatively, pin-prick air photos to document site location. Order copies of the necessary photos for reference site files. Removing District file photos, pricking holes in them, and keeping them in your reference site files will earn few friends.

Use standard cartographic symbols (from the legend of a U.S. Geological Survey topographic map) or label all symbols as to their meaning.

Fine detail isn't necessary unless it helps to locate the site. A detailed site map will be prepared as the next phase of the process.

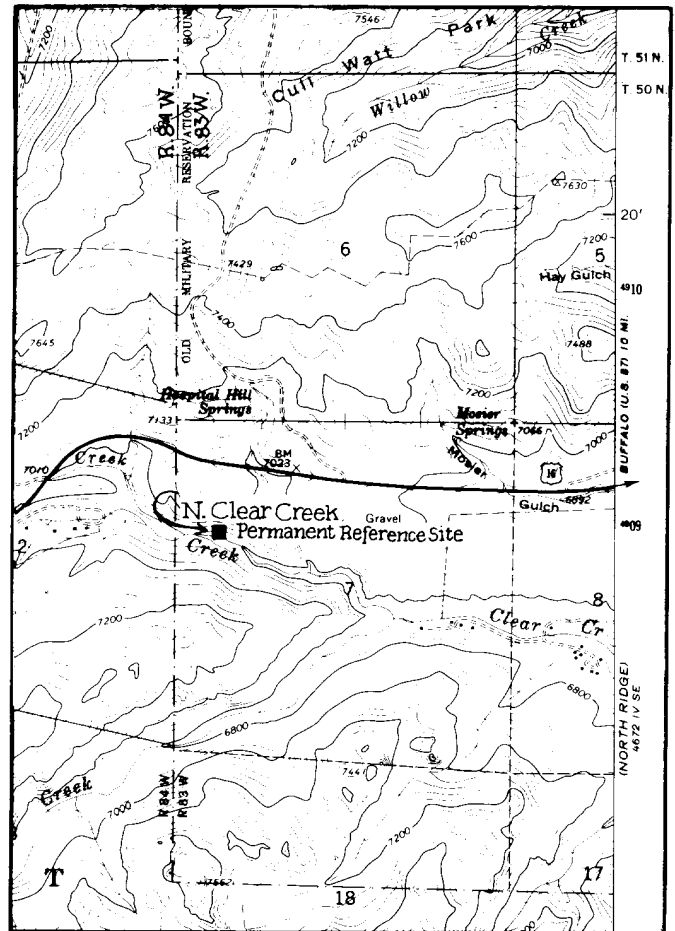

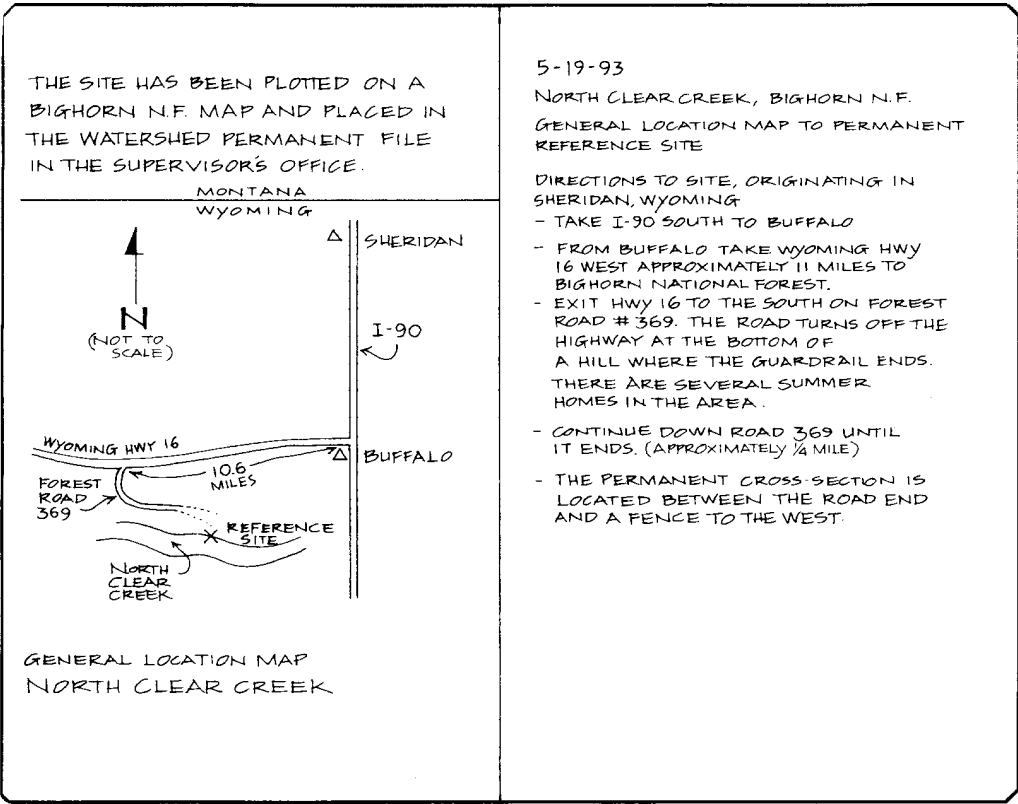

Figure 5. - Sketch-map from field book.

4. Drawing a Site Map

Draw the site map in the field notebook from direct observation. It should show the main features of the site and their relationship as accurately as possible. As field work continues, modify the map with features such as floodplain and terrace elevations. Draw additional maps in the field notebook to record features of the channel and supplement survey notes during field work if needed.

Scale the map to show the entire reach surveyed (a complete meander wavelength, as long as 20 channel widths, or two complete bends). Size the map to include prominent features such as terraces, floodplains, significant vegetation breaks, etc. Often, climbing a nearby slope will lend the perspective for a useful sketch (fig. 6). The idea is to locate the channel in the immediate landscape to determine changes over time. The initial site map of the reach on North Clear Creek (Buffalo Ranger District, Bighorn National Forest) serves as an example (fig. 7).

FIELD NOTEBOOKS

Most hydrologists use bound field books (such as mining transit books with water-resistant surface sizing). These are about 5" x 7", with alternate graph pages, ledger pages, and various tables and equations at the back for reference. Laid flat, they photocopy onto 8-1/2" x 11" sheets for standard filing. Make notes and maps dark enough to photocopy well. Unless you have a special, indelible pen, pencil is a wiser choice than ink, since it won't run when wet. Survey notes should never be erased. Draw a line through errors and initial corrections. Mechanical pencils with 0.5 mm or 0.7 mm leads are widely used. Special pens for writing in the rain are available.

Leave at least two or three pages at the front of the field book blank to list the book's contents by stream, date, and page number (fig. 8). Draw a key to map symbols inside the front cover, or



Figure 6. - Panoramic view of North Clear Creek looking S.W.

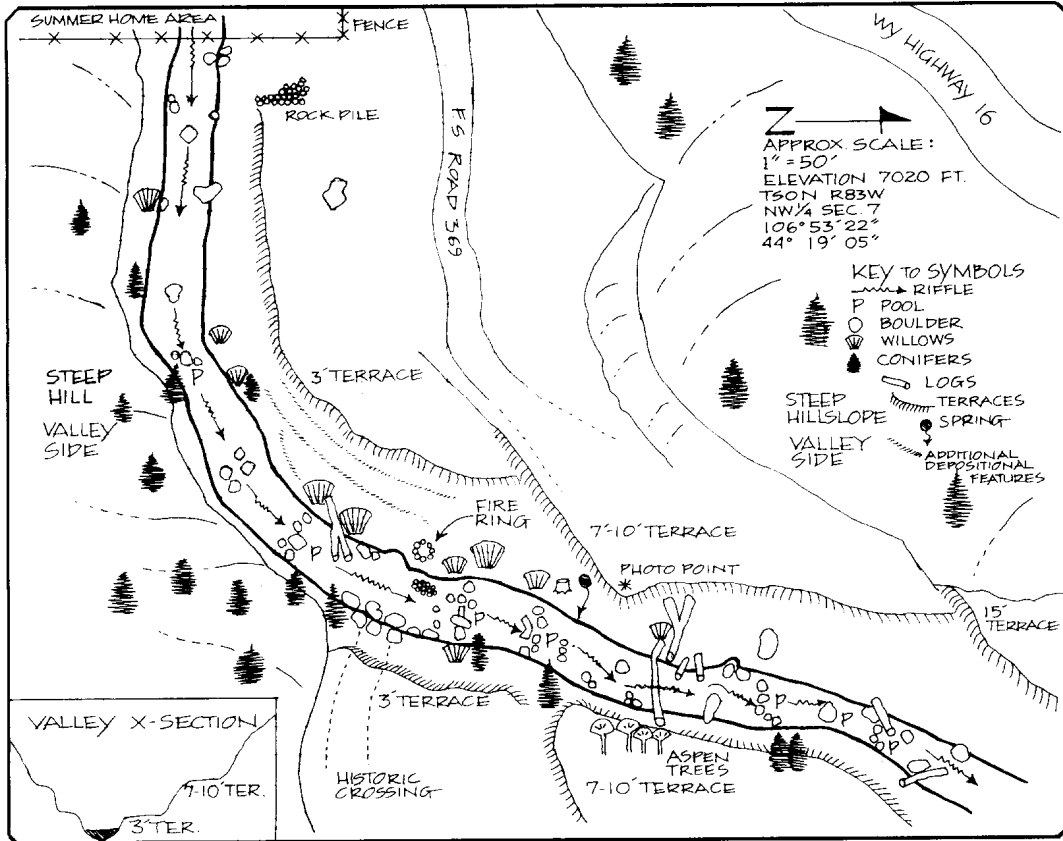

Figure 7. - Initial site map of North Clear Creek, Buffalo Ranger District, Bighorn National Forest.

INDEX - BOOK #1		
SUBJECT	DATE	PAGE
NOTEBOOK #1		
JULY 1992 - SEPTEMBER 1993		
CHERYL HARRELSON		
LINCOLN NATIONAL FOREST		
DITCH CREEK	7-2-92	1
BOULDER BASIN X-SECTIONS	7-10-92	12
SURVEY NOTES	7-26-92	20
SACRAMENTO RIVER LINCOLN NATL. FOR.	10-16-91	25
McKITTRICK CANYON LINCOLN NATL. FOR.	3-15-92	30
MILLS CANYON TRAILHEAD	3-20-92	35
HAY CANYON	4-2-92	42
N. CLEAR CREEK - BIGHORN NATL. FOR.	5-18-93	51

Figure 8. - Title page and index from field notebook.

copy a key from a standard reference and paste it in. Number all pages in each field book. Title or number field books with indelible marker (preferable to adhesive labels) on the face and spine (e.g., Bighorn National Forest, Stream Project, 1994. Volume 1).

Show the following items in field notes and on the site map. Some are self-evident, while others will be explained in the sections covering survey and measurement techniques that follow. This list can be a good reminder for mapping in the field:

- STREAM NAME
- DATE
- SURVEYOR NAMES
- LOCATION OF BENCHMARKS
- DIRECTION OF STREAM FLOW
- NORTH ARROW
- NOTE ON MAP SCALE (e.g., Not to Scale or 1" = 50 ft.)
- GENERAL SITE ELEVATION (e.g., 6200 ft.)
- LANDMARKS NEAR STREAM
- PHOTO POINTS
- LEGEND WITH SCALE
- KEY TO SPECIAL SYMBOLS
- VALLEY CROSS-SECTION SKETCH
- TERRACES (HEIGHT, VEGETATION)
- FEATURES (TREES, ROCKS, DEBRIS)
- LATITUDE/LONGITUDE
- POOL/RIFFLE SEQUENCES
- GRAVEL AND SAND BARS

- ABANDONED CHANNELS
- FLOODPLAIN BOUNDARIES
- CROSS-SECTION (ENDPOINT, BEARING, AND DISTANCE TO BENCHMARK)
- LONGITUDINAL STATIONS FOR SLOPE MEASUREMENTS
- PEBBLE COUNT LOCATION
- OTHER DATA SITES (BANK, BEDLOAD, BARS, RIPARIAN VEGETATION)
- U.T.M.: UNIVERSAL TRANSVERSE MERCATOR (OPTIONAL)

The field book map is a minimum. For greater precision, prepare a planimetric map. If very precise mapping (e.g., total station theodolite) is needed, prepare the map only after site selection is firmly established.

Planimetric stream mapping is outlined by Gordon et al., (1992), p. 139, and also by Newbury and Gaboury (1993), p. 51. The precision achieved by this technique requires considerably more time and field help than the sketch map, but also supports detailed research efforts.

Low-level aerial photographs may also be a useful analytical tool. Check on whether photos of your site can be worked into a scheduled flight. Eventually electronic global positioning systems and GIS software will allow computer documentation of sites, but in terms of simplicity, cost, and immediate access, a good field book sketch map is a necessary element.

Once the site is accurately mapped, the actual field work begins. The next section discusses basic surveying techniques and procedures for establishing permanent benchmarks. The section builds a foundation for the field work that follows.

5. Surveying Basics

A basic field survey establishes the horizontal and/or vertical location of a series of points in relation to a starting point (called a benchmark). If you're familiar with basic surveying techniques, this manual will be a useful review. Specific procedures for the longitudinal profile and cross-section surveys are further detailed in Chapters 6 and 8.

Your survey will record stream dimensions and quantify the relative position of features with the precision needed to document changes. This is vital to support further work at the reference site. Technical considerations include

- fully referencing all benchmarks and measurement points;
- checking regularly for errors and providing suitable closure; and
- following accepted note-taking format and reporting standards.

This type of survey requires at least two persons, and three are best. Minimum equipment (fig. 9) includes

- surveyor's level (with or without stadia hairs);
- leveling rod (English or metric standard);
- 100' tape to match rod (either feet-and-10ths or metric) and another tape for stretching at the cross section;
- field book;
- small sledge and wood survey stakes for stationing and reference; and
- steel rebar (at least 4') and hacksaw, as needed for cross-section endpoints, pins, etc.

A comprehensive list of gear for reference site use appears in Appendix A.

NOTE-TAKING

As described earlier, a waterproof mining transit book is recommended. For convenience, a belt case holds the notebook, scales, pencils, etc. (fig. 10). Durable cases are made of leather or less costly nylon cases are also available.

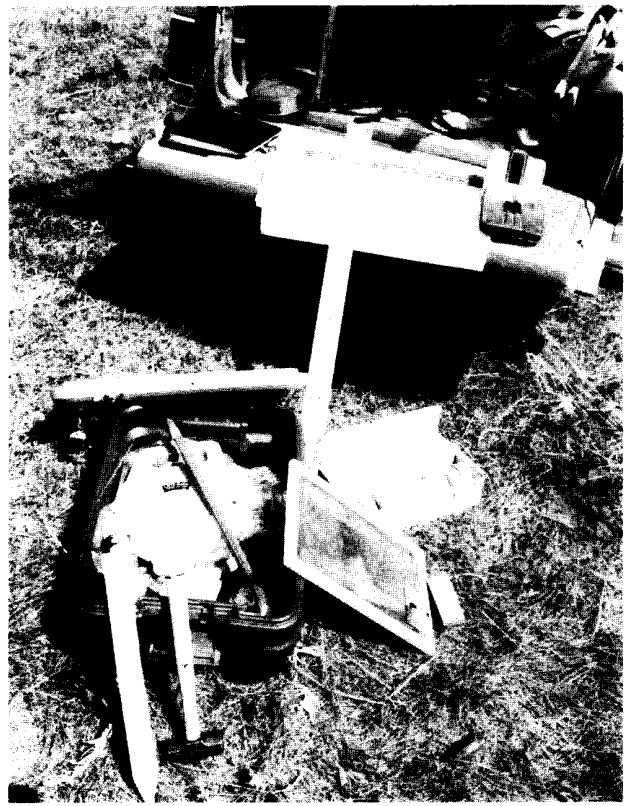

Figure 9. - Survey equipment.

Catalogs for engineering or forestry supplies are sources of suitable cases. Surveyor's or forester's vests also work well.

To help order field notes, prepare an introductory page with name of project, purpose, and other relevant notes such as instrument checks (fig. 11). Prepare notes before starting each day's work or when you start a new site.

- Always record the date and weather.
- Record the names and tasks of the crew (e.g., W. Emmett, level; C. Rawlins, rod; C. Harrelson, notebook).
- Make a note of instrument manufacturer type and serial number (e.g., Instrument: Zeiss Level #2455).
- Identify supplemental forms used and not included in the field book (e.g., USGS form # 9-207 used for summary of discharge measurements).



Figure 10. - Field book and belt case.

- Use adequate spacing for clarity and concentrate on legibility (e.g., distinguish clearly between 1 and 7, letter O and zero 0, 2 and Z).

These are some standard symbols or labels for recording stream surveys in the field book. Left and right banks are always identified facing downstream.

- BM — Benchmark
- HI — Height of Instrument
- FS — Foresight
- BS — Backsight
- TP — Turning Point
- WS — Water Surface
- FP — Floodplain
- LT — Low Terrace
- MT — Middle Terrace
- HT — High Terrace
- LB — Left Bank
- RB — Right Bank
- LEW — Left Edge of Water
- REW — Right Edge of Water
- CL — Centerline (of channel)
- PB — Point-Bar
- BKF — Bankfull Indicator
- SB — Stream Bed
- Top Rif — Top of Riffle/End of Pool
- PB — Point-Bar
- End Rif — End of Riffle/Top of Pool

	5-19-93	5-19-93 COOL, CLOUDY, RAIN PAST 3 DAYS
PROJECT NAME:	NORTH CLEAR CREEK BIGHORN NATIONAL FOREST	ESTABLISHMENT OF PERMANENT REFERENCE STATION ON NORTH CLEAR CREEK
	T50N, R83W, NW¼, SEC. 7 APPROXIMATELY 11 MILES WEST OF BUFFALO, WY. OFF HWY. 16.	- PERMANENT X-SECTION W/BENCHMARK - LONGITUDINAL PROFILE SURVEY - SITE MAP - PEBBLE COUNT - DISCHARGE MEASUREMENT
PURPOSE:	TO ESTABLISH A PERMANENT REFERENCE SITE FOR MONITORING CHANNEL CHARACTERISTICS.	* CROSS SECTION & DISCHARGE COMPLETED 5-19-93. WATER IS TOO HIGH FOR OTHER MEASUREMENTS AT THIS TIME.
SURVEY PARTY:	HARRELSON POTYONDY RAWLINS EMMETT	FIELD CREW: HARRELSON □ NOTES POTYONDY ⚓ INSTRUMENT EMMETT ▮ ROD RAWLINS PHOTOS
NOTES:	CHANNEL IS A B-2 CHANNEL TYPE. FLOW IS NEARLY AT BANKFULL. WADING CHANNEL MAY NOT BE SAFE. AN ADDITIONAL FIELD DAY IS ANTICIPATED.	ZEISS LEVEL # 2455 10:35 A.M.
		PEG TEST

Figure 11. - Introductory pages in field book.

BENCHMARKS

The benchmark is the initial reference (or starting) point of the survey. The U. S. Geological Survey typically uses brass monuments set in rock, a concrete pylon, or a pipe driven deeply into the ground. If one of these is within your survey area, use it. Usually, though, you will need to establish a new benchmark. The elevation of this benchmark may be assumed (100 is normally used) or tied into a project datum or mean sea level.

Locate the benchmark outside the channel (and floodplain, if possible) yet near enough to be clearly visible. The best placement is on a permanent natural feature of the site, such as an outcropping of bedrock, or the highest point of a large boulder. A large, embedded boulder on the low stream terrace is ideal. Four recommended methods for establishing a benchmark are

1. Boulder monument—choose a large, embedded boulder with a single high point. To achieve the least visual impact, clearly draw both its profile and location on your site map so that no artificial mark is needed. Otherwise, mark the high point on the boulder with a lightly chiseled X, a spot of slightly-contrasting paint, or a drilled hole with expansion bolt or cemented carriage bolt.
2. Spike monument—drive a 40-80 penny spike into the base of a large, healthy tree so the rod can be set on its head and be visible (no overhanging branches, etc.). Note the assumed elevation on a reference stake. Two stakes can be hinged to identify the site and protect the reading. Select a healthy tree (typically a conifer-like pine or Douglas fir) 14" or larger in diameter, with roots protected from stream erosion, and not subject to windthrow.
3. Cement monument—dig a circular hole 1-2 feet deep, mix concrete, and fill the hole. Then place a 6" plated (not black) carriage bolt into the center, flush. A variation is to cut and place steel or PVC pipe (at least 6' diameter) in the hole as a form, fill it with concrete, and set the bolt.

4. Rebar monument—drive a piece (at least 3-4' long with a 1/2" diameter) vertically to within 1/2" of the ground surface. Cover it with a plastic cap available from survey supply houses, or tag it with an aluminum survey marker tag.

Figures 12 - 15 show various types of benchmarks.

For long-term permanent sites, use two benchmarks. This allows recovery if one is lost and helps detect errors. Tie these benchmarks to a common datum elevation.

Obvious markers such as painted stakes may annoy other visitors and be subject to vandalism. Make permanent marks for the survey in an unobtrusive location, bearing in mind that they must be found in 5 or 10 years from the notes in your field book. Remove temporary flagging, stationing stakes, and other marks when the survey is complete.

Decide on the locations of the benchmark and the monumented cross-section concurrently, before survey measurement begins.

MONUMENTED CROSS-SECTION

The monumented cross-section lies across the stream (perpendicular to the direction of stream flow). Generally, the cross-section is central to the survey area. Locate a good site for the cross-section before starting survey measurements. Locate the benchmark monument close to this cross-section and mark the endpoints with rebar.

The cross-section is the basis for delineating channel form, for measuring current velocity, and calculating discharge. These measurements are the basis for developing at-a-station hydraulic geometry and for long-term records of stream flow.

Carefully choose a representative cross-section in the surveyed reach. It should not be located where the character of the channel changes, for instance at a break in channel slope, or where a pool gives way to a riffle or at meander bends (unless you specifically wish to study meander movement). Avoid features such as large boulders, big deadfalls, etc., that have altered the extent and form of the channel. Figure 16 shows sample notes for the cross-section survey.



Figure 12. - Boulder monument.



Figure 14. - Cement monument.

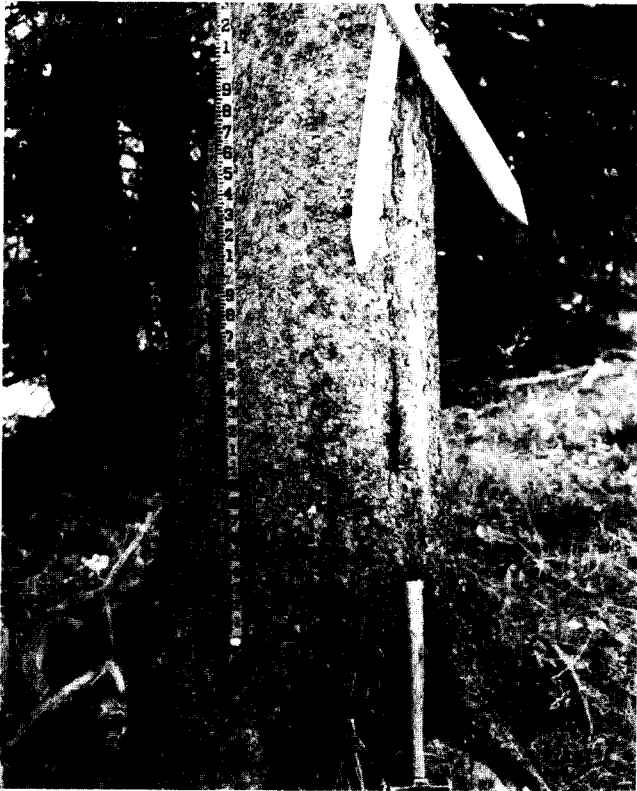

Figure 13. - Spike monument.



Figure 15. - Rebar monument at cross-section (capped rebar on left, next to silver stake).

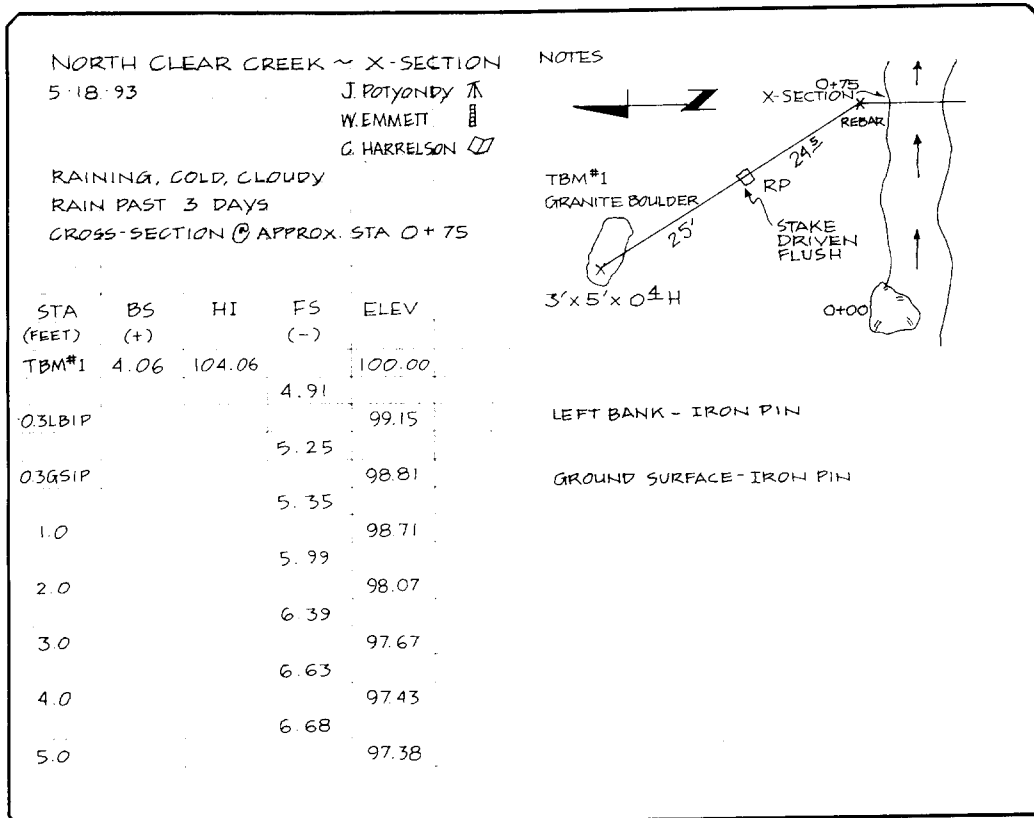

Figure 16. - Sample notes for cross-section survey.

LONGITUDINAL PROFILE SURVEY

Conduct the longitudinal profile survey when you conduct the benchmark and monumented cross-section surveys. The cross-section survey measures a single vertical plane across the stream. Using similar methods, the longitudinal profile measures points up and down the stream channel.

The longitudinal profile survey is important for measuring the slope of the water surface, channel bed, floodplain, and terraces. The elevations and positions of various indicators of stream stage and other features are recorded and referenced to the benchmark.

The following sections concentrate on basic techniques, surveying terms, and keeping the field book. Chapter 8 covers the actual process of surveying a longitudinal profile. Figure 17 shows an example of field book setup for surveying the longitudinal profile.

DISTANCE MEASUREMENTS

Horizontal measurements include: distances between benchmarks and prominent features,

cross-sectional distance, distance along the channel centerline and banks, station distances, and slope. Measure distance by stretching a tape or by reading stadia with the level. For most purposes, the tape is simpler, faster, and just as accurate as stadia-measured distances.

Measuring Tapes

Use a tape of sufficient length (at least 100 feet) to allow measurement without repeated "leapfrogging." Choose a durable, waterproof tape, graduated in feet to 0.1 or meters to 0.01. The tape should be to the same standard (English or metric) as your leveling rod. Obtain tapes from survey and forestry suppliers. Figure 18 shows two common types.

Use of Stadia

Horizontal, straight-line distances can be measured indirectly with stadia. Many surveying levels have smaller horizontal cross hairs above and below the main horizontal cross hair (fig. 19).

NORTH CLEAR CREEK - LONGITUDINAL PROFILE					NOTES	
9/10/93		- WATER SURFACE	L SCHMIDT	⊕	SURVEY POINT LEGEND	
		- BANKFULL	W EMMETT	⊞	LEW - LEFT EDGE OF WATER	
		- TERRACES	C HARRBLSON	⊞	REW - RIGHT EDGE OF WATER	
WARM & CLEAR		11:00 AM				LFP - LEFT FLOODPLAIN
						RFP - RIGHT FLOODPLAIN
						℄ - CHANNEL BOTTOM
						L TERR - LEFT TERRACE
						R TERR - RIGHT TERRACE
STATION (FT)	BS (+)	HI	FS (-)	ELEV (FT)		
TBM #1	6.25	106.25		100.00	BENCHMARK - GRANITE ROCK	
0+00			5.60	100.65	3' TERRACE	
0+00			9.20	97.05	NO FLOODPLAIN EVIDENT	
0+00			11.55	94.70	LEW	
0+15			5.81	100.44	℄	
0+15			7.74	98.51	LFP	
0+15			9.29	96.96	LEW	
0+15			10.66	95.59	℄	
0+15			9.16	97.09	REW	

Figure 17. - Sample notes for longitudinal profile survey.

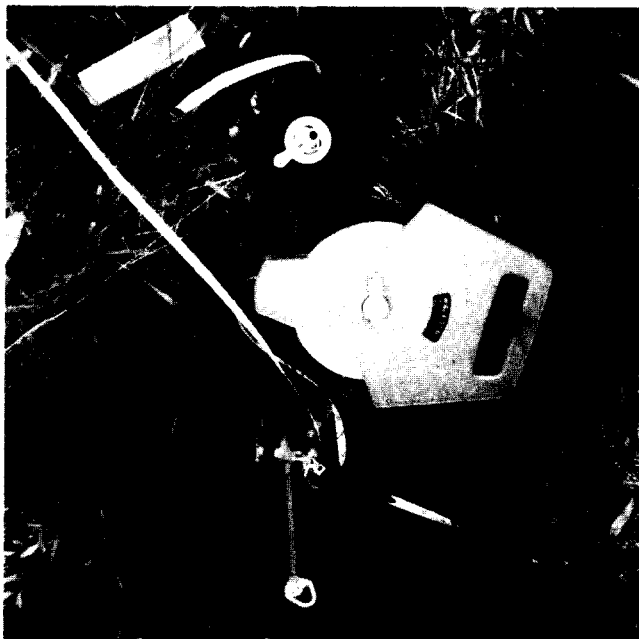

Figure 18. - Two common measuring tapes.

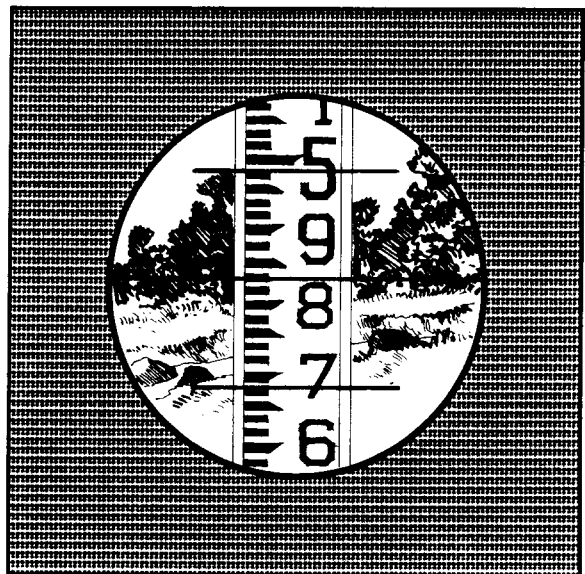

Figure 19. - View through level showing center and stadia cross-hairs.

The distance between the level and rod is found by subtracting the rod reading for the lower stadia cross hair from that for the upper stadia cross hair, and multiplying the result by a stadia constant (usually 100). To be accurate,

readings must be in a level plane, with the rod exactly vertical. If using a transit (rather than a level), read vertical angles and use correction tables to get an accurate reading.

The accuracy of stadia measurements depends on the individual, the type of instrument and rod used, and atmospheric conditions. Unless you have practical experience using stadia, we suggest that you use the tape and rod.

ELEVATION MEASUREMENT

For this survey, measure vertical distances with a basic surveyor's level. A self-leveling level is commonly used for surveying river channels (fig. 20). Another instrument that can be used is a laser level. It projects a beam in a circular plane through a rotating prism. It requires use of a special level rod with a detector that is moved up or down until the beam intersects it. Calculate elevation by subtracting the rod reading from the elevation of the laser plane. Measuring elevations with a laser level requires only a single person with laser-leveling rod and field book.



Figure 20. – Self-leveling level.

Laser Level

Another instrument that can be used is a laser level. A laser level projects a beam in a circular plane through a rotating prism. It requires use of a special level rod with a detector which is moved up or down until the beam intersects it. Calculate elevation by subtracting the rod reading from the elevation of the laser plane. Measuring elevations with a laser level requires only a single person with laser-leveling rod and field book.

CARE OF SURVEY INSTRUMENTS

Because malfunctions in survey instruments can cause tremendous losses of time and field data, a few general rules are in order:

- When transporting instruments, protect them from impact and vibration. (When you have the choice of allowing your friend, your dog, or your level to ride on the seat, choose the level. Secure it in place with the seat belt.)
- Place the level on a firm base in a vehicle rather than on top of other equipment.
- Store the lens cap and tripod cap in the level case while the level is in use.
- Keep the case closed while the instrument is in use.
- Don't run while carrying the level, don't drop it, and *never* fall with it. If you do, the level may need repair and recalibration. (See Two-Peg Test, p. 20.)
- Never force screws or parts when adjusting or maintaining your level.
- Use the sunshade to protect the lenses.
- Clean the lenses only with compressed air or special lens cloth, not with fingers, sleeves, kerchiefs, etc.

SETTING UP THE LEVEL

These procedures apply to a self-leveling level. For other types, refer to the proper manual or instruction sheet.

1. Screw the level snugly to the head of the tripod. "Snug" means finger-tight. Overtightening can cause warping of the tripod plate or instrument, which results in inaccurate measurement.
2. Spread the tripod legs 3 or 4 feet apart, adjust the legs to level the tripod in both directions, and push them firmly into the ground.
3. Move the leveling screws one at a time or in pairs to bring the bubble into the target circle on the vial (fig. 21). Rotate the scope 90° and re-level. Start by leveling across two of the screws and finish with the third screw after making the 90° degree turn.
4. Repeat until the bubble stays level throughout a 360° circuit. With a self-leveling level, this procedure brings the instrument into the range where the leveling pendulum prism can operate.
5. Turn the telescope to bring the rod into the field of vision.
6. Focus on the cross hairs by adjusting the eyepiece. If the cross hairs appear to travel over the object sighted when the eye shifts slightly in any direction, parallax exists. To eliminate parallax, adjust either the objective lens system or the eyepiece until the cross hair appears to rest on the object site regardless of slight changes in your eye position.
7. Avoid readjusting the leveling screws once the instrument is leveled. If the leveling screws must be adjusted to bring the bubble into the target, reread the benchmark elevation and instrument height.

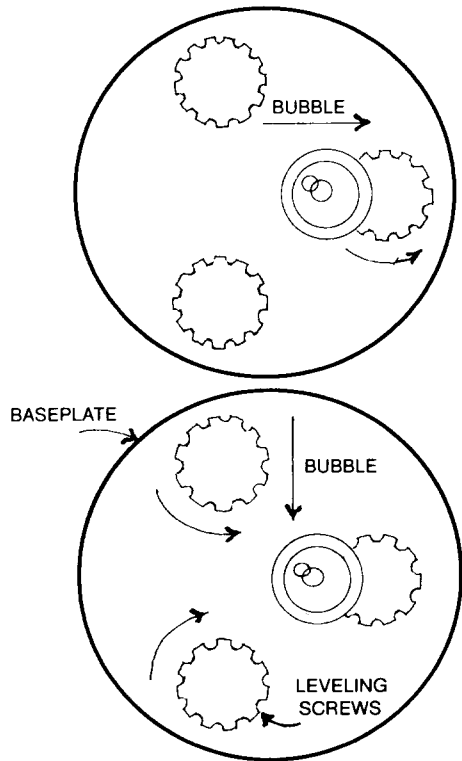

Figure 21. - Centering the bubble.

TWO-PEG TEST

Check surveying instruments before field work by doing a two-peg test. Perform a peg test the first time the instrument is used, when damage is suspected, or when custody of the instrument changes.

- 1) Drive two stakes near ground level 200-300 feet apart with a clear line of sight.
- 2) Set up the level exactly halfway between the two points. Take a rod reading "a" on stake A and a second reading "b" on stake B. The elevation difference computed, "a - b," is the true difference regardless of instrument error.
- 3) Set up the level close enough to stake A so that a rod reading can be taken either by sighting through the telescope in reverse or by measuring up to the horizontal axis of the telescope with a steel tape.
- 4) Take a rod reading "c" on Stake A and a rod reading "d" on Stake B.

If the instrument is in adjustment, $(c - d)$ will equal $(a - b)$.

If the instrument is out of adjustment, compute what the correct rod reading "e" on B should be $(e = b + c - a)$ and have the instrument adjusted.

A sample calculation of the peg test follows:

a = 5.93	a - b = .33	instrument is okay
b = 5.60	c - d = .33	
c = 5.96		
d = 5.63		

READING THE ROD

The rod is marked with a scale, either English or metric. It may be the traditional wood-and-metal type or be made of plastic. Both types have telescoping sections. The rod may be collapsed for transport or field maneuvers, but each section must be fully extended for readings.

The rod person makes or breaks the survey. Knowing what to measure (i.e., where to set the rod) is the most vital part. The rod person sets the pace of the work and often influences or directs the movement of the level.

The numbers on the face of the rod show distance from its lower end. In the English standard, distance is numbered in feet (large number) and tenths (small number). The width of one individual black line is 1/100 (or .01) ft., and the width of a white space between black lines is also 1/100 (or .01) ft. (fig. 22). On the metric rod, distance is numbered with a decimal point, in meters and tenths. The width of black marks and white spaces is 1/100 (or .01) m.

The rod person should hold the rod lightly and let it balance in the vertical position. The level operator watches through the telescope as the rod person rocks or waves the rod forward and backward through the plumb line, noting the minimum rod reading (fig. 23). The minimum reading occurs when the rod is plumb. A com-

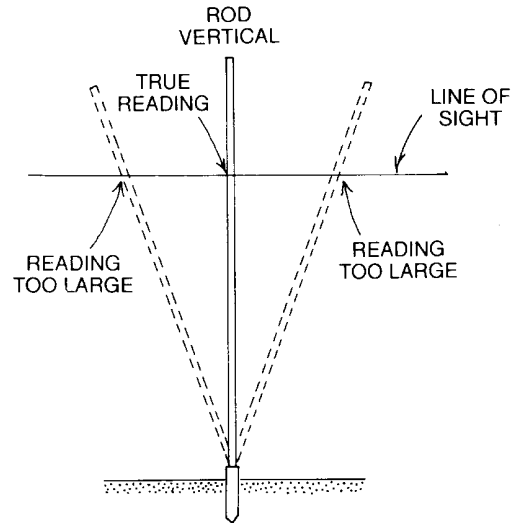

Figure 23. - Rod in three positions.

mon cause of error when sighting is reading the elevation on a stadia hair instead of the central cross hair.

Use a rod level to ensure an accurate reading. A rod level has a small bull's-eye spirit level, mounted on an L-shaped bracket attached to the rod. A centered bubble indicates the rod is plumb in both directions. Plumb is very important when determining channel characteristics and water surface elevations.

Once you have mastered the basics of setting up the level and reading the rod, check instrument accuracy by using a simple two-peg test.

LEVELING

Many survey procedures are based on differential leveling, that is, they find the elevation of an unknown point by direct measurement of the difference in elevation between that point and a point of known (or assumed) elevation. Profile leveling determines the elevations of a series of points at intervals along a line.

Terms Used in Leveling

Backsight (BS) is a rod reading taken on a point of known elevation. It is the actual vertical distance from the point of known elevation to a horizontal line projected by the instrument. There is only one backsight for each setup of the instrument. (The term "backsight" has nothing

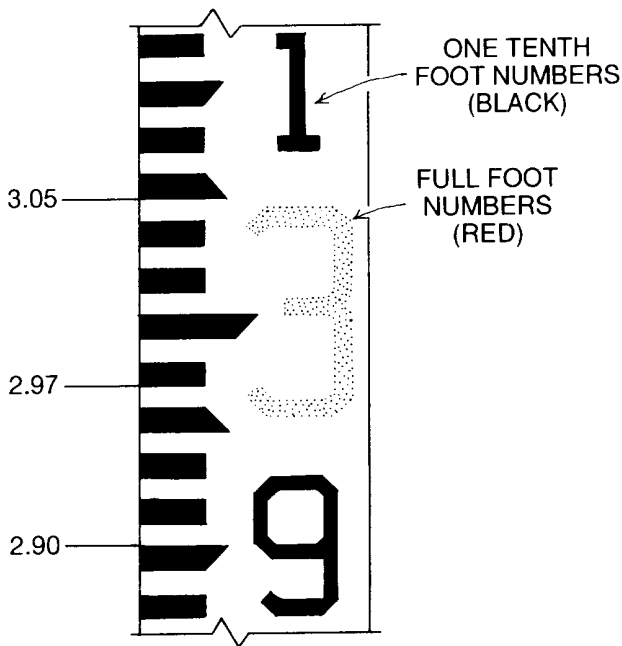

Figure 22. - Leveling rod.

to do with the direction in which the instrument is pointed.) The algebraic sign of the backsight is positive (+) because adding this value to the benchmark or turning point elevation gives the height of the instrument.

Height of Instrument (HI) is the elevation of the line of sight projected by the instrument. Find it by adding the backsight rod reading to the known (or assumed) elevation of the benchmark or the point on which the backsight was taken.

Foresight (FS) is a rod reading taken on any point to determine its elevation. The algebraic sign for the foresight is negative (-) since the FS is subtracted from the HI to find the ground elevation of the point in question.

Turning Point (TP) is a reliable point upon which a foresight is taken to establish elevation. A backsight is then made to establish a new HI and to continue a line of levels. The turning point retains the same elevation while the instrument is moved. Set the rod on a turning point and record a foresight. Move the instrument as the rod stays in place. Make a backsight and record it. Large rocks are often used as turning points.

DIFFERENTIAL LEVELING

Differential leveling measures the relative elevations of points some distance apart. It consists of making a series of instrument setups along a route. From each setup, take a rod reading back to a point of known elevation and a reading forward to a point of unknown elevation.

The points for which elevations are known or determined are called benchmarks or turning points. The benchmark is a permanently established reference point, with its elevation either assumed or accurately measured. A turning point is a temporary reference point, with its elevation determined as a step within a traverse.

For example, the elevation of benchmark 1 (BM1) is known or assumed to be 100.00 feet (figs. 24 and 25).

The elevation of BM2 is found by differential leveling. Set the instrument up first at some point from BM1 along the route to BM2. Hold the rod on BM1 and note the rod reading (5.62) in the field notebook. This reading is a backsight (BS), or a reading taken on a point of known elevation (fig. 26).

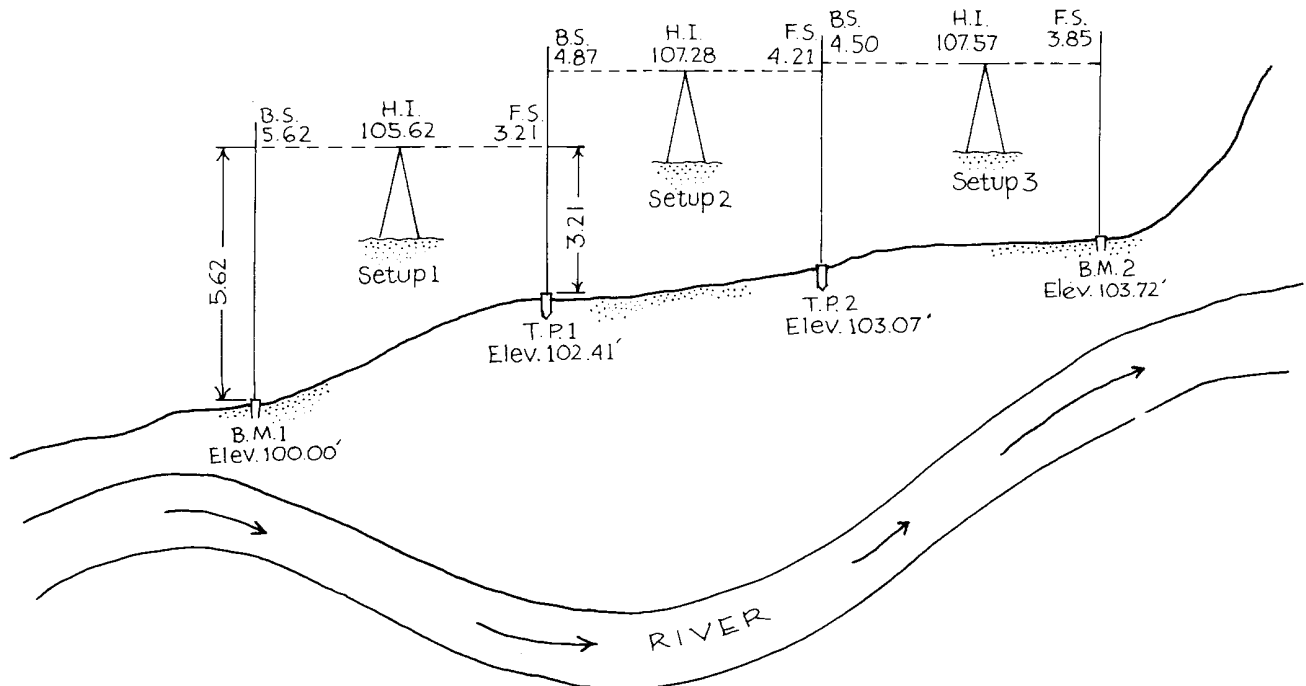

Figure 24. - Diagram of differential leveling.

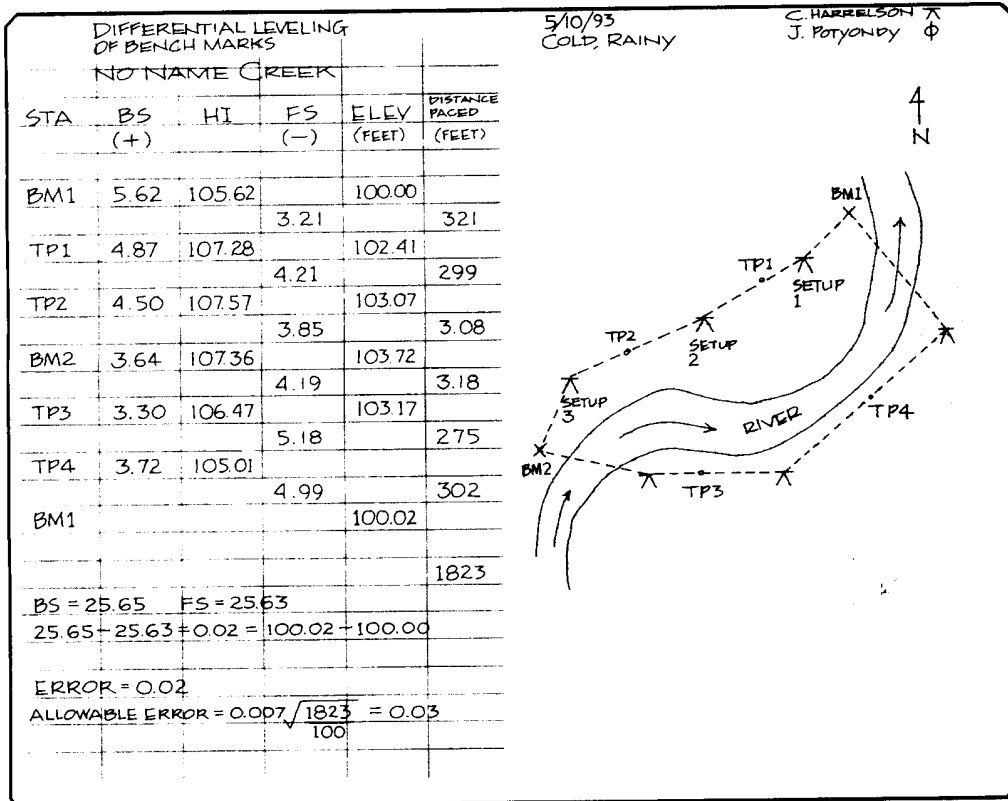

Figure 25. - Field notes for differential leveling.

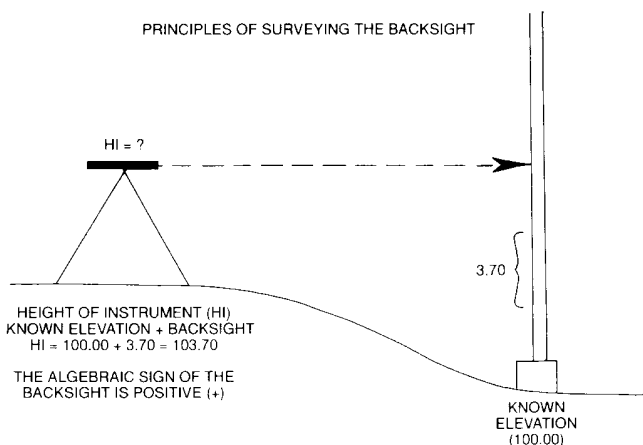

Figure 26. - Surveying the backsight.

Add the backsight reading on BM1 to the elevation of BM1 ($100.00 + 5.62 = 105.62$) to give the height of instrument (HI).

Once the backsight on BM1 is recorded, the rod person moves to turning point number 1 (TP1). With the instrument still at setup 1, take a reading on TP1. This reading is a foresight (FS), a reading taken on a point of unknown elevation (fig. 27).

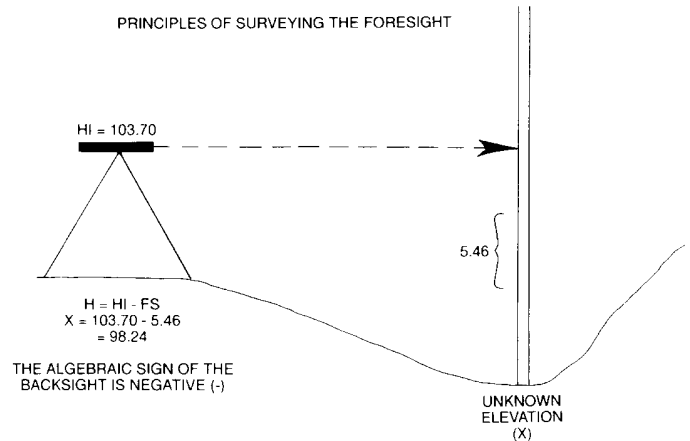

Figure 27. - Surveying the foresight.

Enter the foresight (3.21) in the field notebook opposite TP1. Compute the elevation of TP1 by subtracting the foresight on TP1 from the instrument height ($105.02 - 3.21 = 102.41$) and enter this elevation on the notes opposite TP1. TP1 now becomes a point of known elevation. Figure 28 shows the principles of turning points.

The rod person remains at TP1 while the instrument is moved to setup 2. From here take

PRINCIPLES OF SURVEYING TURNING POINTS

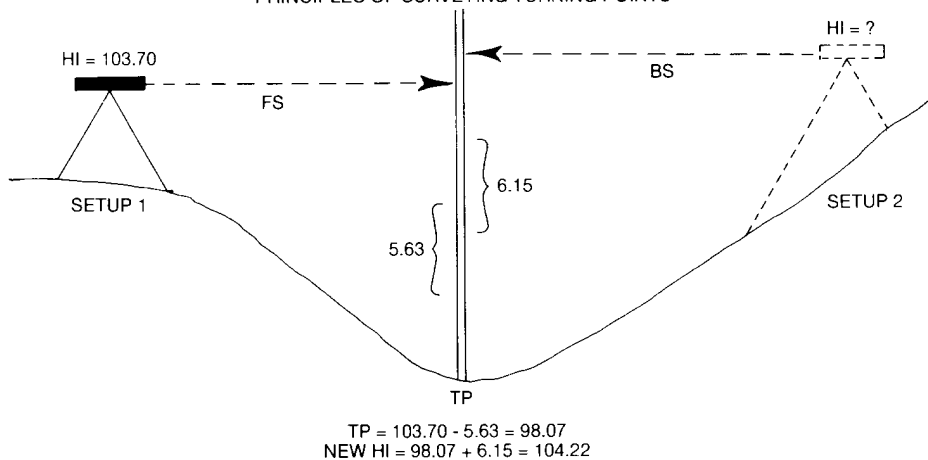

Figure 28. - Turning points.

another backsight BS on TP1. Determine the new HI, establish TP2, and determine its elevation. Figures 24 and 25 should make this procedure clear. This same procedure is carried through until reaching BM2.

arithmetic errors are found, failure to close may be due to errors in reading the rod, or note-taking. In any event, the line of levels must be resurveyed to locate and correct the error.

Closure of the Survey

To check on the accuracy of the survey, run a line of differential levels from BM2 back to BM1, the original point of known or assumed elevation. No survey is complete until it has been closed within acceptable levels of error. The difference between the original elevation of BM1 and the new or calculated elevation is the error. Very small errors may result from rounding and are acceptable. Acceptable error depends on the intent of the survey. Typically a closure of .02 ft. is acceptable when doing river surveys. One equation to estimate allowable error is:

$$0.007 \sqrt{\frac{\text{total distance}}{100}}$$

A large error may result from mistakes in calculation, so check your arithmetic first. If no

PROFILE LEVELING

Essentially, profile leveling is a process of differential leveling with many intermediate foresights between turning points. The longitudinal survey along a stream channel uses profile leveling.

As shown in figures 29 and 30, foresights taken from setup 1 are each subtracted from HI at this setup to determine the elevations of the intermediate points between BM1 and TP1. Find the elevations of points (rod settings on features, indicators, etc.) between TP1 and TP2 in a similar manner. Locate the instrument for the best visibility so that necessary features can be measured without changing the setup.

The next section applies the basic principles learned in this section to the measurement of a channel cross-section. During this process, you will use surveying techniques to establish the elevation and location of the permanent benchmark and then measure elevation and distances along the cross-section across the channel.

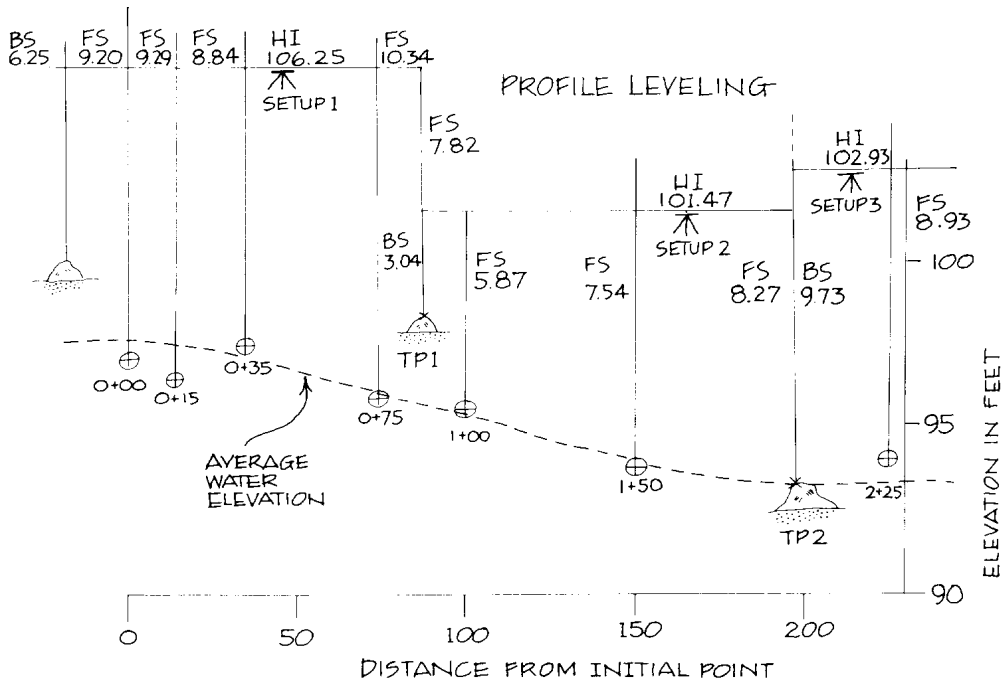

Figure 29. - Diagram of profile leveling.

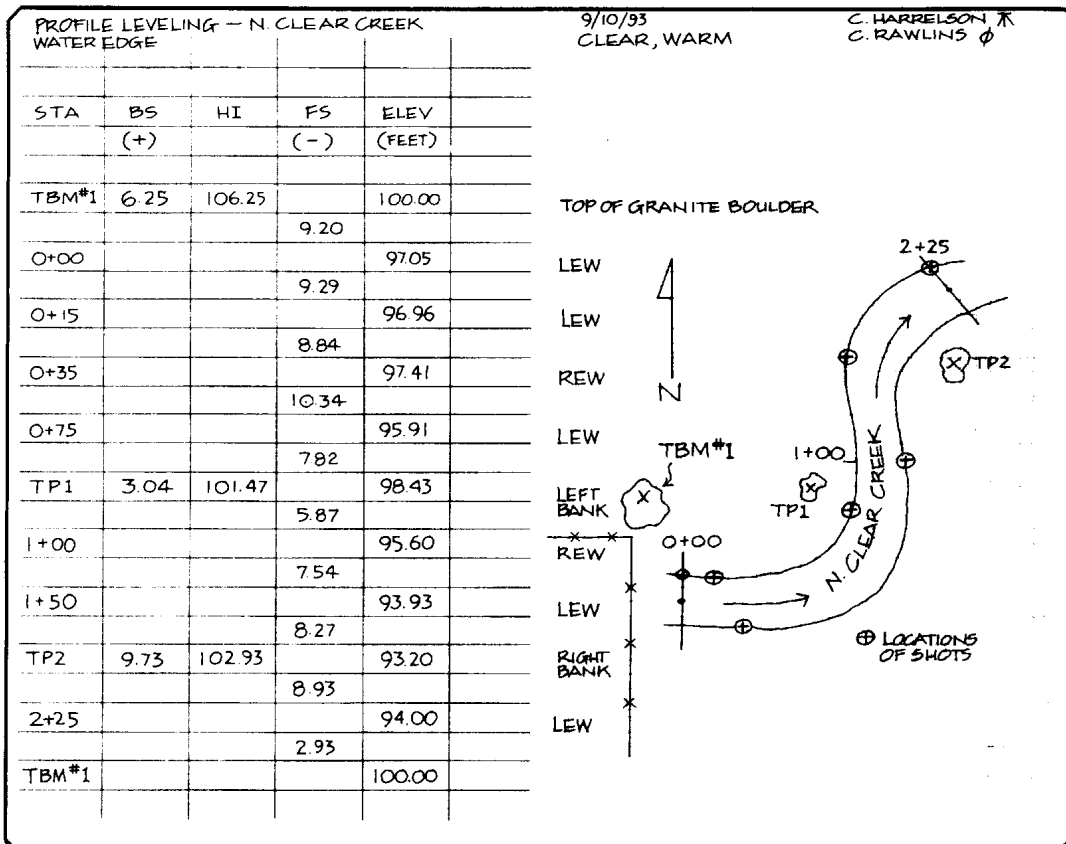

Figure 30. - Field notes for differential leveling.

6. Measuring Channel Cross-Section

The monumented cross-section is the location for measuring channel form, stream discharge, particle size distribution, and other long-term work. Though more than one cross-section may be needed depending on the objectives of the study, only one is used in this example.

The cross-section survey involves placing endpoints and a benchmark, stretching a tape, taking documentary photos, and measuring elevations with a surveyor's level. At least 20 measurements are recommended to accurately portray most channels, with more needed for broad or structurally complex sites (such as braided channels). Remember to measure all significant breaks of slope that occur across the channel. Outside the channel, measure important features including the active floodplain, bankfull elevations, and stream terraces.

Figure 31 shows a general diagram of the channel cross-section.

The stream must be waded repeatedly to complete the survey. If possible, schedule the work when water levels allow safe wading of the stream, or anchor a safety rope if needed.

Features to look for when locating the permanent cross-section include

- a straight reach between two meander bends;
- clear indicators of the active floodplain or bankfull discharge;
- presence of one or more terraces;
- channel section and form typical of the stream;
- a reasonably clear view of geomorphic features.

Place marked endpoints for the cross-section well above the banks, or at the edge of the low terrace. A tape will be stretched between these points. Once the endpoints have been chosen, mark them with sections of rebar (at least 4' long, driven vertically). The cross-section survey may extend beyond the ends of the tape to delineate not only the present channel and banks but also one or more stream terraces.

Figure 32 shows a suitable site for a channel cross-section.

CROSS-SECTION SURVEY PROCEDURE

1. **ESTABLISH PERMANENT MARKERS FOR ENDPOINTS.** Drive a 4' x 1/2" piece of re-bar vertically into each bank to mark endpoints, leaving 1/2" above surface. Attach colored plastic caps, available from survey supply houses, to the top of the rebar for identification. Note their use, and in the case of multiple cross-sections, their color, in the field book. In most instances, drive a second, shorter piece of rebar next to the first, leaving at least 6" above surface, to attach your tape.
2. **ESTABLISH THE BENCHMARK.** The benchmark establishes elevation and survey controls, and it serves to relocate the cross-section in the future. Methods of locating monuments for a benchmark are covered in Chapter 5, Surveying Basics. Figure 33 shows how to describe the benchmark in the field book.

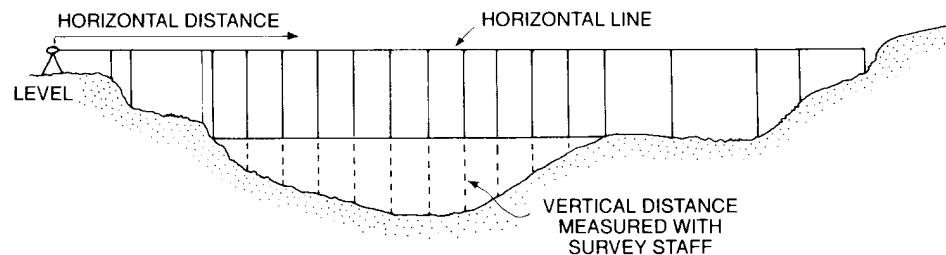

Figure 31. - Diagram of a cross-section survey.



Figure 32. - Suitable site for a cross-section survey.

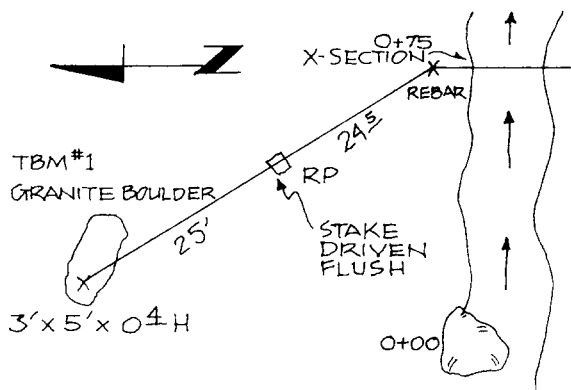

Figure 33. - Description of benchmark in field book.

3. **MEASURE AND NOTE ENDPOINT LOCATIONS.** With the tape, triangulate between a benchmark, the nearest endpoint, and another permanent feature (an embedded boulder or healthy, long-lived tree away from the water's edge). Measure taped distances to 0.1 of a foot. Record the triangulation or straight line reference point in the field book.
4. **SET UP THE TAPE.** Attach the zero end of the tape to the left stake. Stretch the tape tight and level

above the water from the triangulated endpoint to the opposite endpoint of the cross-section. Use spring-clamps, Silvey stakes, or other means to hold the tape. If the stream is so wide that the tape sags excessively, use a tag line that can be stretched straight. Record the total distance between endpoints in the field book. Leave the tape set up for a discharge measurement.

5. **MEASURE ELEVATIONS.** Set up the surveyor's level, as covered in Chapter 5. Start with the rod on the benchmark to establish the height of instrument (HI) (fig. 34). Starting with the left endpoint stake as zero, begin your channel cross-section. (Starting from the left side makes for easy plotting of cross-section data.) The plot looks like the cross-section measured in the field. Along the tape, shoot an elevation at each change in each important feature, or at intervals that delineate important features. Set the rod on slope breaks (such as the edge of the low terrace), on indicators of active floodplain boundaries or bankfull discharge, and on other features of interest.



Figure 34. - Shooting the elevation of the benchmark.

Always measure the edge of water. Place the rod firmly on the wetted bottom but don't dig it in. Once in the channel, shoot elevations at a regular interval (basically, either channel width divided by 20, or 1 or 2 foot intervals are commonly used) with additional shots to capture features such as breaks in slope. Avoid the tops of isolated boulders and logs (or shoot at close intervals to accurately record large ones). Continue across the channel to the right endpoint stake. If necessary, go beyond the stake to measure terrace features on the far bank.

Record distance and depth measurements in the field notebook without erasures as shown in figure 35. Line out, correct, and initial any errors.

Measurement standards differ according to purpose. Distances are usually measured to tenths of feet for cross-section and profile surveys. For recording the distance between cross-section elevations, measuring to hundredths may increase the accuracy to a desired standard, if moving the rod a few inches affects the reading dramatically. Elevations are always recorded for hundredths (0.01 ft.) when leveling benchmarks, turning points, height of instrument, or slope.

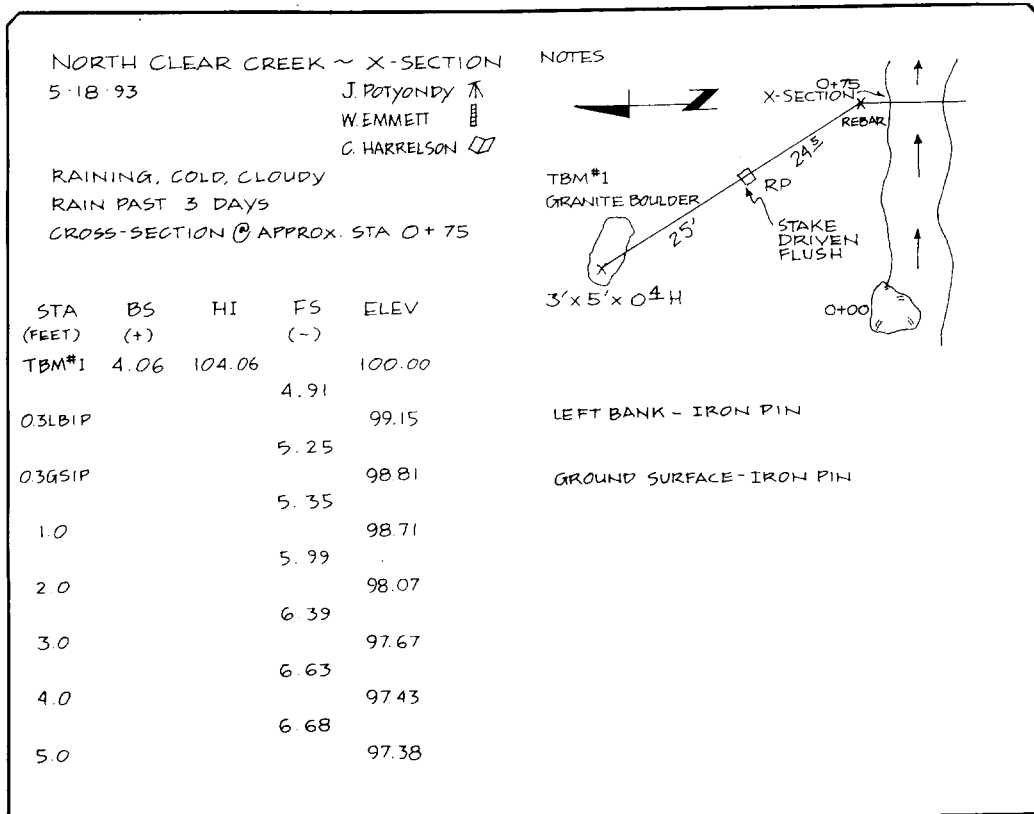

Figure 35. - Survey notes for cross-section.

Many people take all elevations to 0.01. This increases the precision of the survey and may make it easier to close.

6. **CLOSE THE SURVEY.** Remember to close the survey loop by taking a reading back to the initial benchmark. Doing this properly requires moving the instrument at least once during the course of the survey. Shooting directly back to the benchmark without moving the instrument only detects movement of the level (perhaps by having accidentally knocked one of the legs), not instrument errors. Take a reading on a temporary turning point (transect endpoints are convenient for this purpose), move the instrument across the stream, shoot the endpoint a second time, and follow this with a reading on the initial benchmark. If movement across the stream is difficult or if vegetation obstructs a clear shot, move the instrument the distance of a channel's width along the

bank on the same side of the stream and close the survey loop back to the benchmark. Calculate closure in the field before leaving the site and repeat measurements if necessary.

7. **PLOT THE DATA IN THE FIELD BOOK.** Always plot the data while in the field (fig. 36). This helps to catch errors and gives you a better feel for how your site translates into a notebook record. The purpose of your study will dictate whether to (1) extend the plot to the floodplain or terrace elevations, or (2) plot the channel cross-section alone. For visual emphasis, the vertical scale of the plot may be exaggerated by a factor of 10.

Figure 37 shows a final plot of the field data prepared in the office.

8. **MEASURE CHANNEL SLOPE.** For the slope measurement, the rod person moves upstream from the cross-section far enough to incorporate one complete pool-riffle or step-pool se-

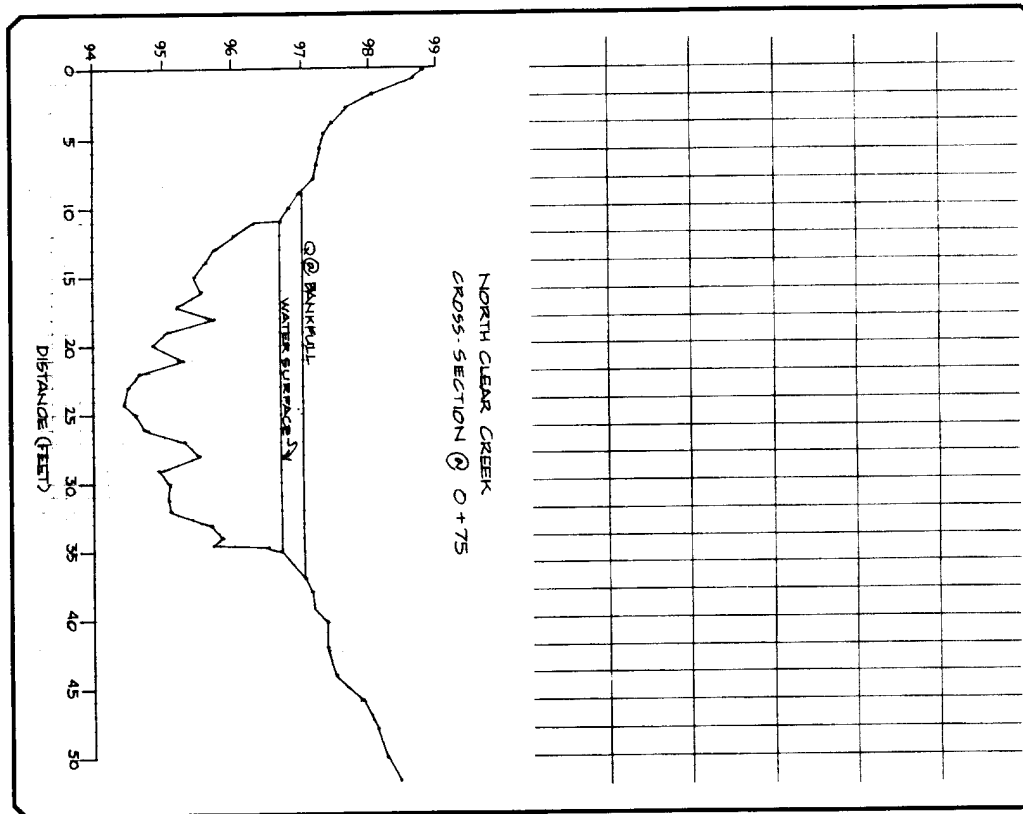

Figure 36. - Field plot of cross-section.

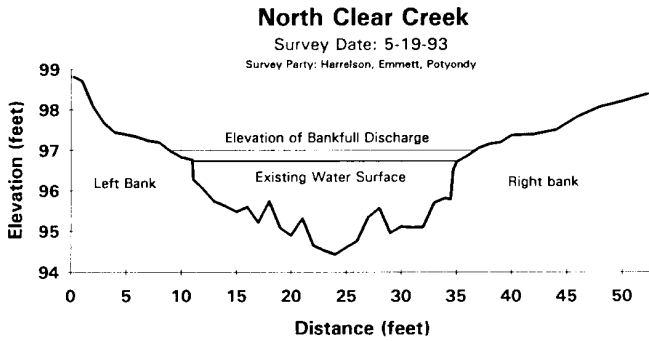

Figure 37. - Final plot of cross-section.

quence (if present). Start at a distinct feature (top of riffle, pool, etc.) and measure the distance from the cross-section to each point with a tape to the nearest 0.1 ft. Shoot elevations at water surface and bankfull. (If the survey is done at bankfull stage, that will also be the water surface elevation as was the case on North Clear Creek.)

Repeat the procedure downstream, ending on the same channel feature as at the starting point. For example, if the upstream slope measurement point was the top of a riffle, the lower slope measurement point would also be the top of a riffle (fig. 38). Record the data in the field book and check for potential errors.

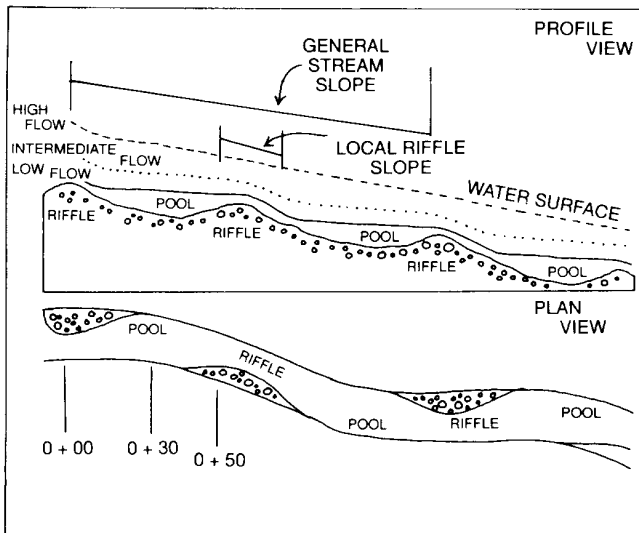

Figure 38. - Longitudinal profile and plan view of pool riffle sequence.

For North Clear Creek (at bankfull stage), the observations were

Upstream Distance	=	55.5 ft.
Downstream Distance	=	+94.5 ft.
Total Distance (run)	=	150.0 ft.
Downstream Water Surface	=	10.87
Upstream Water Surface	=	- 6.22
Elevation Change (rise)	=	4.65

$$\text{SLOPE (\%)} = \frac{\text{rise}}{\text{run}} \times 100 = \frac{4.65 \text{ ft}}{150.0 \text{ ft}} \times 100 = 0.031 \times 100 = 3.1\%$$

PLOT OF SLOPE

- ESTABLISH PHOTO POINTS. Record the camera, lens focal length, and film type in the field notebook. A 35mm camera with a fixed-focus normal (50mm) and a wide-angle (28-35mm) lens or setting (focal lengths shorter than 28mm causes distortion) is recommended. Take photos upstream, downstream, and across the channel (figs. 39, 40, and 41). Try to include the entire cross section with both endpoints, and the tape in place, in the frame. Show the benchmark in another photo looking across the site, if possible.

Reference your photo points by triangulating to the endpoint and/or benchmark. To avoid confusion, mark photo points by some means different from endpoint benchmarks. If precision is needed for stereo photos, use a tripod to support the camera rather than driving steel fence posts.

Generally, use color slide film to document field studies. (For this publication, sample cross-section photos were shot with black-and-white film.)

The next section discusses how to identify natural features along the stream. Primary interest centers on identification of the floodplain, bankfull flow indicators, and channel terraces. The process of measuring the elevation of these features and the distance separating them along the length of the channel is called a longitudinal profile. Detailed procedures for doing a longitudinal profile are discussed after the section on identifying these features.



Figure 39. - Cross-section from the left bank looking across.

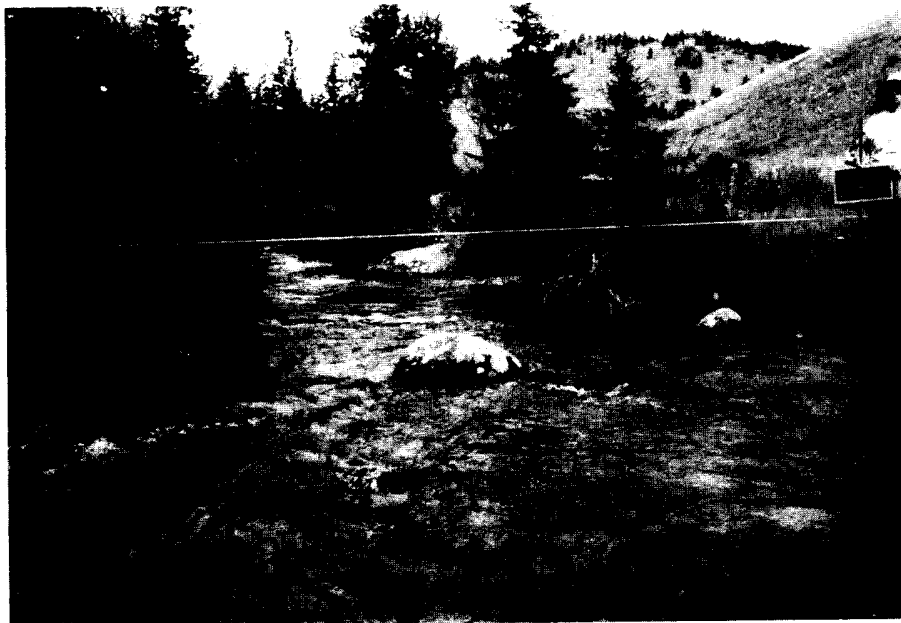

Figure 40. - Cross-section view upstream.

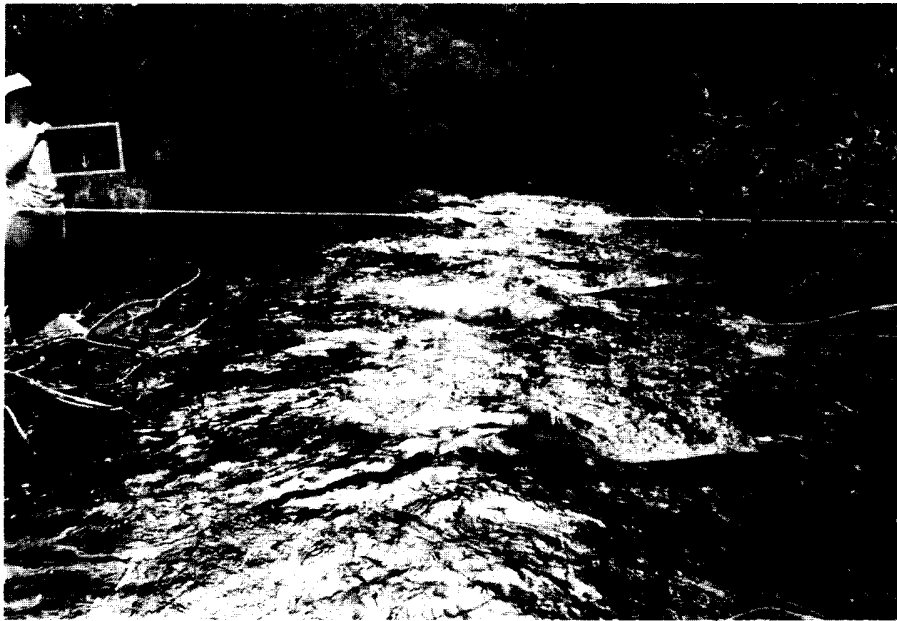

Figure 41. - Cross-section view downstream.

7. Floodplain and Bankfull Indicators

Using the basic survey techniques covered in the previous chapter, you can accurately quantify and map the major features of a stream channel and the surrounding landscape it has formed. The benchmark you establish is a permanent reference point for the survey. The next questions are: What natural features should be measured and mapped? Where do you set the rod?

Some valuable indicators of stream character, such as the edges of the water and the channel bottom, are easy to locate. Yet others of equal importance, such as bankfull discharge, and the boundaries of the active floodplain, are harder to define. If you observe the stream at bankfull discharge, the water level will be obvious, but this discharge is infrequent. The average discharge, which you are more likely to encounter, fills about 1/3 of the channel, and is reached or exceeded only 25% of the time (Leopold 1994).

Bankfull discharge largely controls the form of alluvial channels. It closely corresponds to the effective discharge or to the flow that transports the largest amount of sediment in the long-term under current climatic conditions and may be thought of as the channel maintaining flow. "Bankfull discharge is defined as that water discharged when stream water just begins to overflow into the active floodplain; the active floodplain is defined as a flat area adjacent to the channel constructed by the river and overflowed by the river at a recurrence interval of about 2 years or less" (Wolman and Leopold 1957).

Erosion, sediment transport, and bar building by deposition are most active at discharges near bankfull. The effectiveness of higher flows—called overbank or flood flows—does not increase proportionally to their volume above bankfull, since overflow into the floodplain distributes the energy of the stream over a greater area.

Finding indicators of bankfull stage (or elevation) in order to calculate stream discharge is crucial, but this may be difficult in the field. Stream-types and indicators vary, and the process requires many separate judgments; a lack of consistency by a single person or among several people can yield poor results.

The active floodplain is the flat, depositional surface adjacent to many stream channels. It is

the best indicator of bankfull stage. Floodplains are most prominent along low-gradient, meandering reaches (e.g., Rosgen's type C channel). They are often hard or impossible to identify along steeper mountain streams (Rosgen's types A and B). They may be intermittent on alternate sides of meander bends or may be completely absent. Steep, confined streams in rocky canyons often lack distinguishable floodplains, so other features must be used (Emmett 1975). Recently disturbed systems may give false indications of bankfull.

Where floodplains are absent or poorly defined, other indicators may serve as surrogates to identify bankfull stage. The importance of specific indicators varies with stream type. Several indicators should be used to support identification of the bankfull stage; use as many as can be found. Useful indicators include

- the height of depositional features (especially the top of the pointbar, which defines the lowest possible level for bankfull stage);
- a change in vegetation (especially the lower limit of perennial species);
- slope or topographic breaks along the bank;
- a change in the particle size of bank material, such as the boundary between coarse cobble or gravel with fine-grained sand or silt;
- undercuts in the bank, which usually reach an interior elevation slightly below bankfull stage; and
- stain lines or the lower extent of lichens on boulders.

When measuring indicators of stream stage, set the rod on a stable surface at the level of the indicator. Use pin-flags to mark these points if necessary. Flags are useful if an error leads to a re-survey or if there are dubious points on your field plots requiring discussion and further measurement. Observers need to correlate these indicators to flow measurement at gages and integrate several factors.

INDICATORS OF BANKFULL STAGE

Common bankfull indicators include (figs. 42, 43, 44, and 45):

1. **TOP OF POINTBARS.** The pointbar consists of channel material deposited on the inside of meander bends. They are a prominent feature of C-type channels but may be absent in other types. Record the top elevation of pointbars as the lowest possible bankfull stage since this is the location where the floodplain is being constructed by deposition.
2. **CHANGE IN VEGETATION.** Look for the low limit of perennial vegetation on the bank, or a sharp break in the density or type of vegetation. On surfaces lower than the floodplain, vegetation is either absent or annual. During a series of dry years, such as 1985-1990 in much of the western United States, perennial plants may invade the formerly active floodplain. Catastrophic flows may likewise alter vegetation patterns. On the floodplain (above bankfull stage) vegetation may be perennial but is generally limited to typical stream side types. Willow, alder, or dogwood



Figure 42. - Indicators of bankfull stage: pointbars, undercut bank, and change in vegetation.

often form lines near bankfull stage. The lower limit of mosses or lichens on rocks or banks, or a break from mosses to other plants, may help identify bankfull stage.

3. **CHANGE IN SLOPE.** Changes in slope occur often along the cross-section (e.g., from vertical to sloping, from sloping to vertical, or from vertical or sloping to flat at the floodplain level). The change from a vertical bank to a horizontal surface is the best identifier of the floodplain and bankfull stage, especially in low-gradient meandering streams. Many banks have multiple breaks, so be careful and examine banks at several sections of the selected reach for comparison. Slope breaks also mark the extent of stream terraces, which may be measured and mapped in your survey. Terraces are old floodplains that have been abandoned by a downcutting stream. They will generally have perennial vegetation, definite soil structure, and other features to distinguish them from the active floodplain. Most streams have three distinct terraces at approximately 2 to 4 feet, 7 to 10 feet, and 20 to 30 feet above the present

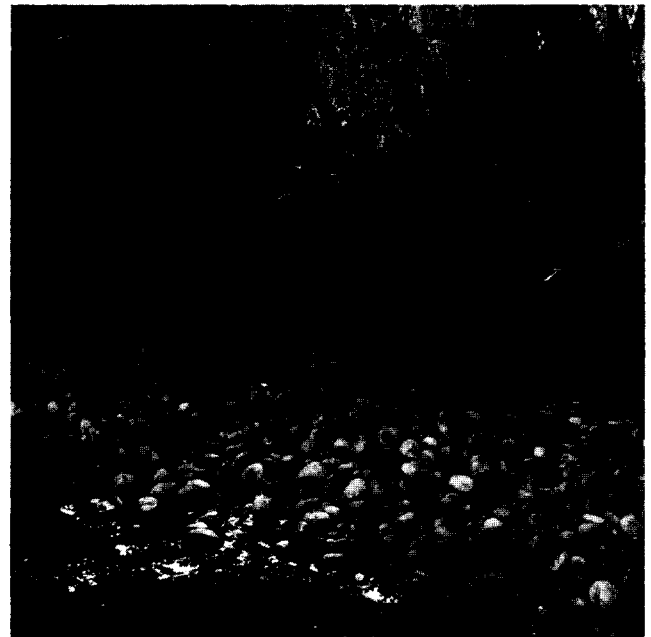

Figure 43. - Change in bank materials. Lower left side of photo shows transition from large cobble to gravel to silt along stream bank.

stream. Avoid confusing the level of the lowest terrace with that of the floodplain: they may be close in elevation.

4. **CHANGE IN BANK MATERIALS.**

Any clear change in particle size may indicate the operation of different processes (e.g., coarse, scoured gravel moving as bedload in the active channel giving way to fine sand or silt deposited by overflow). Look for breaks from coarse, scoured, water-transported particles to a finer matrix that may exhibit some soil structure or movement. Changes in slope may also be associated with a change in particle size. Change need not necessarily be from coarse-to-fine material but may be from fine-to-coarse.

5. **BANK UNDERCUTS.** Look for bank sections where the perennial vegetation forms a dense root mat. Feel up beneath this root mat and estimate the upper extent of the undercut. (A pin-flag may be inserted horizontally and located by touch at the upper extent of the undercut as a datum for the rod.) This is usually slightly below bankfull stage. Bank undercuts

are best used as indicators in steep channels lacking floodplains. Where a floodplain exists, the surface of the floodplain is a better indicator of bankfull stage than undercut banks that may also exist.

6. **STAIN LINES.** Look for frequent-inundation water lines on rocks.

These may be marked by sediment or lichen. Stain lines are often left by lower, more frequent flows, so bankfull is at or above the *highest* stain line.

Deposits of pine needles, twigs, and other floating materials are common along streams, but they are seldom good indicators of bankfull stage. A receding stream may leave several parallel deposits. Floods may also leave organic drift above bankfull stage.

If stream gage data is available for the stream, observations of indicators at or near the gages may help to identify the indicators most useful for a particular area. Ratios of present-to-bankfull discharge can be used to estimate bankfull stage at nearby sites. Bankfull discharges



Figure 44. - Undercut bank and change in vegetation as indicators of bankfull stage.



Figure 45. - Lichen break.

tend to have similar flow-frequency (approximately 1.5 years) and flow-duration characteristics among sites in a given climatic region. Use this ratio and observations of bankfull stage at local stream gages to test the reliability of the various indicators for your geographic area.

Compare your calculation of bankfull discharge to the regional averages by drainage area. Figure 46 illustrates bankfull dimensions of width, depth, and cross-sectional area for four geographic regions. Use the graphs to validate your selected bankfull stage. If it is unreasonably different, examine your methods.

MARKING INDICATORS OF BANKFULL STAGE

The field determination of bankfull stage is basically detective work. Crew members walk the selected reach and mark probable indicators (using pin flags, flagging tied on shrubs, etc.). This usually involves discussion and even some disagreement as to the significance of individual marks.

Wade the center of the channel to view bankfull stage along both banks. During the process, visualize the water surface at bankfull and note channel features such as bars, boulders, and rootwads that may affect water surface elevation or direct the current. The final test of bankfull indicators is measuring their elevation as part of the survey and plotting a longitudinal profile of bankfull elevation for the entire reach. (See figure 53). A line drawn through the points represents the sloping plane of bankfull flow. Significant scatter of bankfull elevations is normal.

Outlying points will be evident and may be rechecked to see what sort of indicators give the most useful and consistent results for the selected reach.

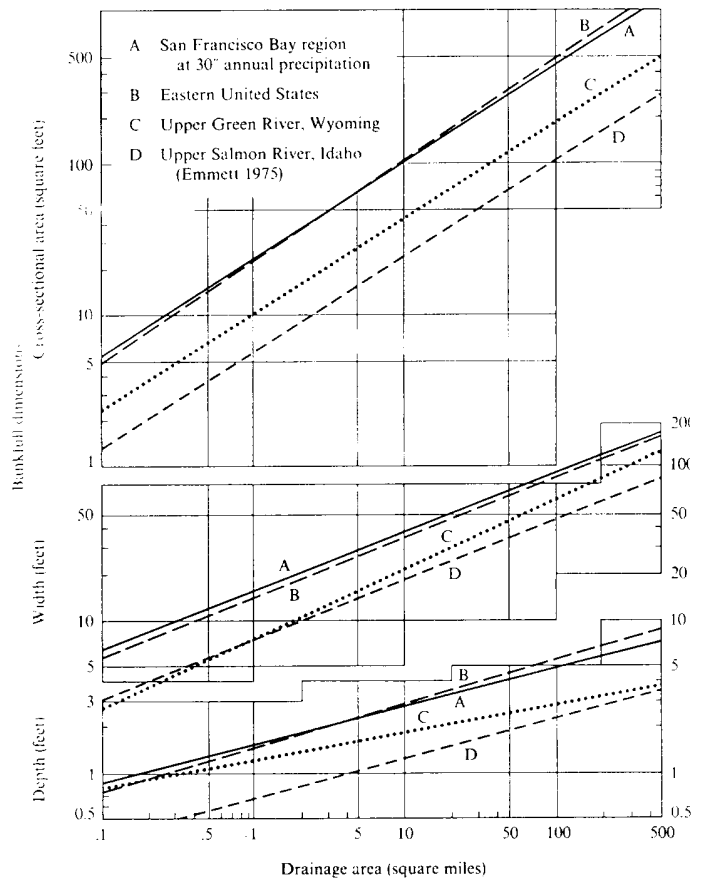

Figure 46. - Average values of bankfull channel dimensions as functions of drainage area for four regions. From: *Water In Environmental Planning* by Thomas Dunne and Luna B. Leopold. Copyright © 1978 by W.H. Freeman and Company. Reprinted with permission.

8. Longitudinal Profile Measurement

The next step in establishing a permanent reference site is to complete a longitudinal survey of the selected reach. The survey establishes the elevation of the existing water surface, channel bottom, bankfull stage, floodplains, and terraces. It then determines their slope through the study reach.

While this manual treats the longitudinal profile after the cross-section survey, you may wish to measure the longitudinal profile first and then use it to influence the location of the cross-section. Experience will dictate an order that works best given the character of the streams you measure and the circumstances in which you work.

Figure 47 shows the information gathered from a longitudinal survey.

LONGITUDINAL PROFILE SURVEY PROCEDURE

1. **DEFINE THE EXTENT OF THE SURVEY FROM YOUR PRELIMINARY MAP AND CLASSIFICATION.** In terms of length, the longitudinal profile extends approximately 300-500 feet along the channel (or approximately 20 times the channel width at bankfull). Extend the width of the survey far enough to measure both banks, the active floodplain, and one or more stream terraces.

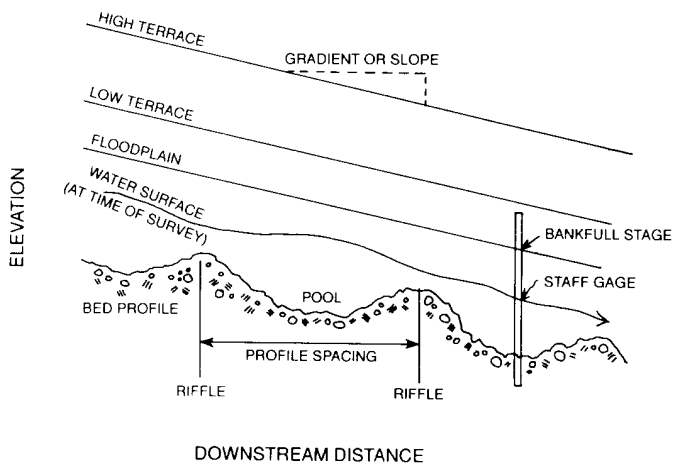

Figure 47. - Graphic representation of longitudinal profile.

2. **FLAG THE CHANNEL AND RELATED FEATURES.** Review Chapter 7 on floodplain and bankfull indicators. Assign various colors of flagging to different indicators of channel-forming flow and to selected features such as terraces. Place flags where features are evident and a sighting with the level is possible (fig. 48).
3. **SET UP THE LEVEL.** Set up the level so the benchmark and most of the site is visible (fig. 49). The best locations are usually on the low stream terrace, because it is stable and close enough to the water surface that rod extensions are minimized. Consider setting up in the stream channel if visibility is limited and if the depth and bottom conditions make this feasible (the stream bottom should be stable and the level must not get wet). Having to move the level often adds time and complexity to the survey: select sites carefully.



Figure 48. - Placing a pin flag at a change in vegetation.



Figure 49. - Good location for level setup.

4. **SELECT STATIONING.** Stations are the intervals at which elevations are measured with the level and rod. Place wooden stakes at each station. Number each by hundreds of feet from zero (0) at the upstream end plus a measured or carefully estimated distance (usually in feet) after the + sign. The starting point is 0 + 00. If the next station is 50 feet downstream, designate it 0 + 50, (i.e., zero hundreds plus fifty ones). Number a station 150 feet downstream as 1 + 50. Number a station 270 feet downstream as station 2 + 70, and so on. Use the width of the channel (rounded to the nearest 5 feet) as the interval between each location.

Select a starting point, station 0 + 00, at the upstream end of the reach, preferably where a pool gives way to a riffle. Note the location of permanent features that will help in relocating your starting point in the future.

5. **MEASURE STATION DISTANCES AND PLACE STAKES.** Measure distances with a tape down the stream centerline as you place a stake along the banks every channel-width and clearly mark the distances on the stakes (fig. 50). These stakes form



Figure 50. - Measuring along the channel centerline and staking.

the baseline for measuring channel distance. If the channel curves, measure the baseline either as a series of broken straight lines down the channel centerline or as a curve along the center of the channel. Place stakes along the edges of the channel perpendicular to flow. This method simply and adequately indicates distance along the channel.

The station of any measurement point is the right angle projection from the baseline or channel center to the baseline along the bank. Estimate longitudinal distances by referring to the stakes.

An alternative to using a tape is to calibrate your pace: Stretch the 100' tape (in the field, not in a carpeted corridor) and walk the length of it. Divide 100' by the number of paces to find your average pace. A pace is two steps (left foot to left foot). Use this as a rough measure of distance when you survey. Where shrubs or other items block straight passage, step 90 degrees to a clear path and resume your count. If you are unsure, a tape measurement is better than a poor estimate by pacing.

The longitudinal profile aims to delineate indicators and features accurately. The stakes placed a channel width apart are used primarily to guide estimation of distances. They do not necessarily fix the locations where measurements are made.

If your project design requires fixed transects, then use them but key each one to a good sequence of features. *Do not use fixed-intervals or stationing to place transects for longitudinal profile measurements.* This is especially important with respect to slope measurement since the location of measurement points must be keyed to channel features such as pools and riffles. Figure 51 shows stationing on the site map.

6. MEASURE ELEVATIONS OF IMPORTANT FEATURES. Measure or carefully estimate distances using the stakes as references. Place the rod and shoot individual elevations of the channel bottom at the center of the stream, bankfull indicators, floodplains, and terraces where they are most apparent and record distance and elevation in the field book. Move the instrument as needed. If

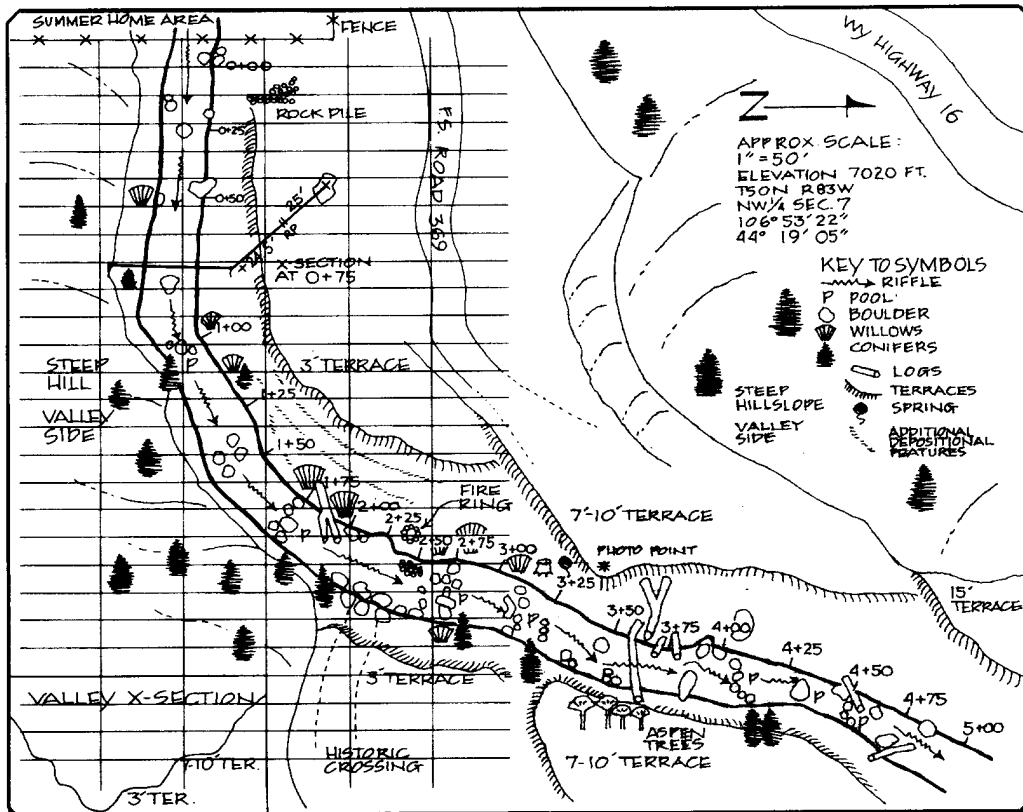

Figure 51. - Site map with stationing.

you can't finish your survey in one day, always mark the water level at your cross-section. The surface elevation of a stream may change between late afternoon and the following morning, which may place some of your survey points in error.

When you record stream surveys in the field book, use the list of standard symbols and labels given in Chapter 5.

Figure 52 shows notes for the longitudinal profile survey of North Clear Creek.

7. **PLOT YOUR SURVEY IN THE FIELD BOOK.** While still in the field, construct a plot of the survey data in your field notebook (fig. 53). Fit a series of straight lines to the

longitudinal profile by eye for the present water surface and bankfull (or floodplain) elevations. If you surveyed terrace elevations, plot them also. Connect the points identifying the channel bottom with straight lines. The lines of slope for the entire reach should closely parallel each other.

Review to see that your survey is complete. Resurvey dubious points or probable errors before you leave the site.

Replot slopes from the longitudinal profile in the office using standard technical drawing tools or computer graphics and file for permanent reference (fig. 54).

NORTH CLEAR CREEK - LONGITUDINAL PROFILE					NOTES	
9/10/93		- WATER SURFACE		L SCHMIDT		
		- BANKFULL		W. EMMETT		
		- TERRACES		C. HARRISON		
WARM & CLEAR		11:00 AM				
STATION (FT)	BS (+)	HI	FS (-)	ELEV (FT)		
BEN #1	6.25	106.25		100.00	BENCHMARK - GRANITE ROCK	
0+00			5.60	100.65	3' TERRACE	
0+00			9.20	97.05	NO FLOODPLAIN EVIDENT	
0+00			11.55	94.70	LEW	
0+15			5.81	94.70	☒	
0+15			7.74	100.44		
0+15			9.29	98.51	LFP	
0+15			10.66	96.96	LEW	
0+15			9.16	95.59	☒	
0+15			9.16	97.09	REW	

Figure 52. - Field notes for longitudinal profile survey.

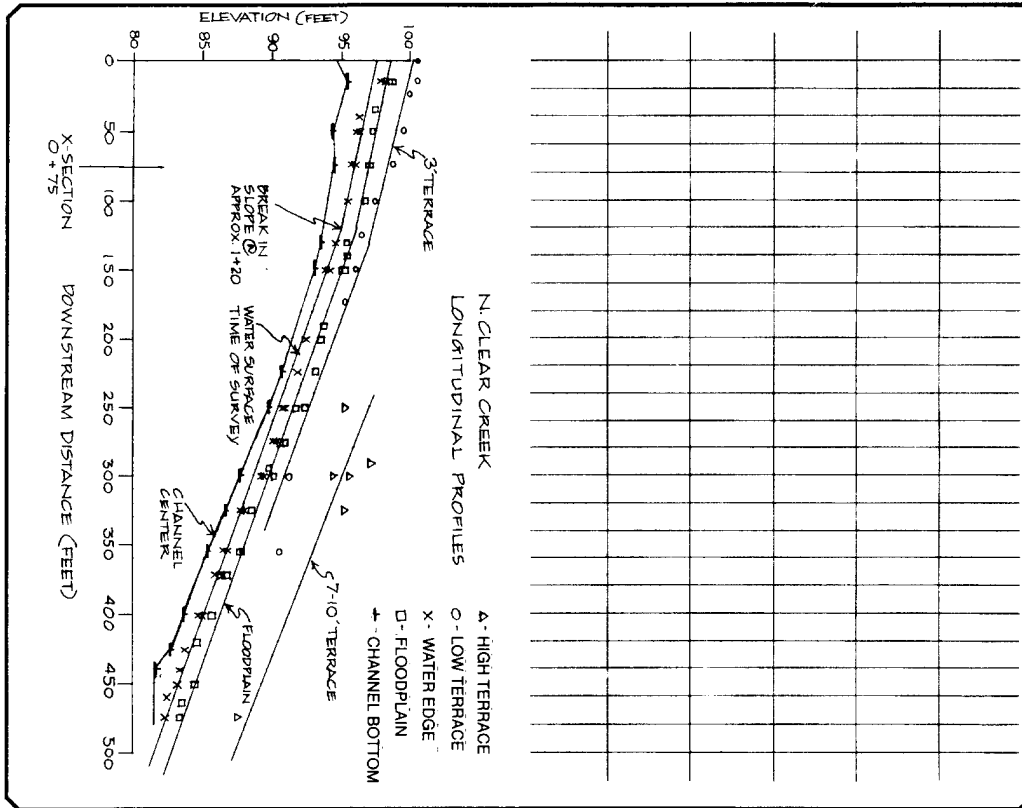

Figure 53. - Field plot of longitudinal profile survey.

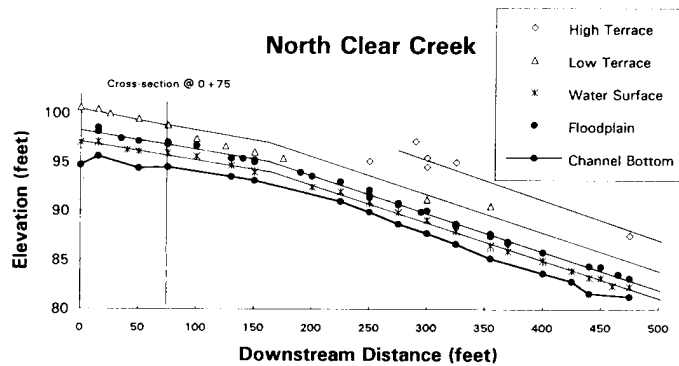

Figure 54. - Office plot of longitudinal profile survey.

9. Installing a Staff Gage

A staff gage is a scale (usually enameled steel, marked in feet and tenths) placed in the stream to show the elevation of the water surface. It is calibrated by referencing the numbered height on the gage to the surveyed elevation of the water surface and its associated flow at the time of installation.

A plot of stage against discharge is known as a rating curve. The rating curve is developed after numerous visits to the site to observe stage and measure stream flow. Once the curve is established, the discharge at any time can be determined by reading gage height alone. Install a staff gage at the cross-section if the site will be monitored on a regular basis (e.g., daily, weekly, monthly). If the site is remote or will be visited irregularly (1-5 year intervals or longer), a staff gage may not be worthwhile in terms of cost and visual impact.

PROCEDURE FOR INSTALLING A STAFF GAGE

1. Locate the gage at the monumented cross-section, making sure the lower end of the gage is within the channel at low flow. Avoid installing the gage in the path of high-velocity currents or floating debris. Position the gage plate to be readable from the zero end of the cross-section or another location accessible during high flows. (Use binoculars in difficult cases, if necessary.)
2. Drive a steel sign post, fence post, or pipe vertically into the stream bed. In stream beds where boulders make this impossible, look for a vertical face on a large boulder, drill holes in the rock, and attach the gage plate with expansion bolts.
3. Wire or bolt the gage plate to the support at a height where it will show the full range of stages for the reach. Annually check the elevation of the staff gage to make sure it has not moved. Set the upper extent of the staff gage with reference to the ob-

served elevations for bankfull and flood stages. Position the gage plate so the full range of stream stages register. For broad ranges, install two staggered gage plates.

4. The staff gage is calibrated to the discharge (Q) at the time of placement. This measurement establishes one point on the stage/discharge curve (rating curve) for the site. Plot the stage/discharge curve on log-log graph paper, with the gage height (GH) in feet as ordinate, and the discharge (Q) in cfs as abscissa. Use a minimum of three points to establish a plot or rating curve. Each point added to the rating curve increases its precision. The more points, the better.

Figure 55 shows a record of gage heights and discharges for Gloom Creek on the Bighorn National Forest.

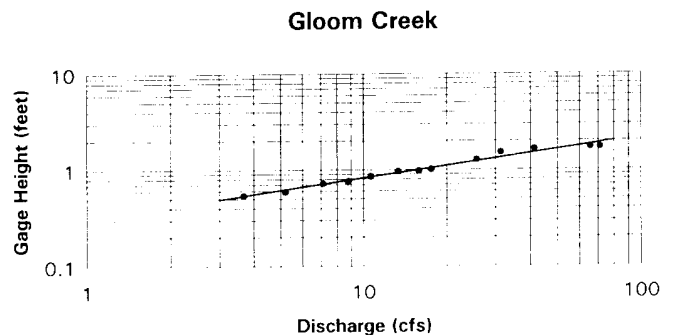

Figure 55. - Rating curve for Gloom Creek, Bighorn National Forest.

CREST GAGES

A crest gage marks the highest elevation of the water surface so that peak flows can be recorded without being present at the site. Various designs exist, but a simple one consists of a transparent tube or pipe (1" - 2" diameter) marked with the same increments as the staff gage. Cover the bottom opening of the tube with a coarse screen to keep debris out. Place a cap with a vent hole on the top (p. 152, Gordon et al. 1992).

To record high flow, use fragments of cork or styrofoam small enough to adhere to the inside of the tube at the high water line. After a peak flow event, uncap the tube and wash the attached particles back to the present water level.

The U. S. Geological Survey recommends 2" galvanized pipe, capped at both ends and vented at the top, with intake holes placed to minimize hydrostatic drawdown or super elevation. A redwood or aluminum staff that fits snugly between the caps is marked in increments matching the

gage plate. Granulated cork is placed inside the pipe after installation. Readings are made by removing the top cap and withdrawing the staff. The crest is indicated by grains of cork adhering to the staff (p. 112, U. S. Geological Survey 1977). The tube is fixed to the back of the support for the gage plate or to another vertical support, with the marked increments matched for elevation (use a level if they are in different locations).

10. Measuring Discharge

Stream discharge (Q) is the volume of water passing a cross-section per unit of time and is generally expressed as cubic feet per second (cfs). Discharge is simply velocity times cross-sectional area ($Q = VA$). Cross-sectional area is determined by stretching a tape across the channel to measure distance at the cross-section locations where depth is measured with a calibrated rod. Area is depth times width in small increments across the channel. A current meter is used to measure velocity at the same location as each depth measurement.

Use a current meter for the initial velocity measurement and subsequent measurements. Use the float method for repeated velocity measurements where time is limited. Although width and depth measurements are made during the cross-section survey, they are measured and recorded separately for calculating discharge.

Figure 56 shows the velocity-area method for measuring discharge using the mid-section method of area determination.

UNDERSTANDING STREAM FLOW MEASUREMENT

Water in a channel flows at different rates depending on its location, so the area of the cross-section is divided into subsections, with one or more measurements taken for each. At least 25-30 measurements are needed for most channels, with no more than 5% of the total discharge (Q) in each. Use more subsections for broad or structurally complex cross-sections.

For computing area, the mid-section method (see fig. 56) uses the vertical line of each measurement as the centerline of a rectangular sub-

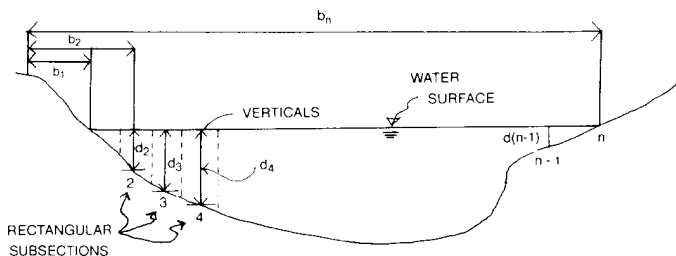

Figure 56. - Diagram of velocity-area method for measuring discharge using the mid-section method of area determination.

section; subsection boundaries fall halfway between the centerlines. Discharge in the triangles at the water's edge, where the water is too shallow to allow a meter reading, are negligible in terms of total discharge.

Multiply the mean velocity for each subsection by the area of the subsection to compute the discharge (Q_n) for the subsection. Sum all subsection discharges to get the total discharge (Q) for the cross-section. The equations for this process are given in a step-wise procedure, later in this chapter.

The field procedure is much like shooting elevations along the cross-section, except the current meter is used instead of the leveling rod. A two-person crew works best, one to operate the current meter and one to take notes (fig. 57). In high streams, or with loose and slippery substrates, wading may be difficult and strenuous. Concentrating on the current meter can make it hard to maintain balance. If the cross-section is



Figure 57. - Measuring current velocity with a Price AA flow meter.

dangerous at high water, use a safety line and a life vest if it seems prudent, or return at a lower flow.

The Forest Service (and most government agencies) use English units for discharge records. A detailed reference for measuring current velocity is Chapter 1 of the *National Handbook of Recommended Methods for Water Data Acquisition* (U. S. Geological Survey 1977).

CURRENT METERS

Meters commonly used to measure current velocity include: Marsh-McBirney, Price AA, and Pygmy.¹ Some brands have rotating cups (like an anemometer on a weather station) while others have a pair of electronic contacts on a small head. Older models read out by clicking or buzzing into a headset. Newer models have digital read-out.

Most current meters mount on a top-setting rod, which allows the current meter to be easily set to the correct depth. Top-setting rods are recommended for discharge measurement because they make the process simpler and quicker.

Examine the meter before going into the field, read the instructions, do a spin test before each measurement, perhaps even test it in running water—use a nearby stream, irrigation ditch, or a garden hose aimed at the cups. Check the batteries and take spares. If you have more than one meter, compare results from the same point and calibrate as necessary. Calibrate your meters prior to the field season. Meter calibration services are available from the U.S. Geological Survey and universities.

PROCEDURE FOR CURRENT VELOCITY MEASUREMENT

1. Stretch a tape between the endpoints of your channel cross-section. Divide the distance between the water's edges by 25 (at least) to set the interval for metering (e.g., the water sur-

face is 22 feet across; $22 \div 25 =$ an interval of 0.88 feet, which can be rounded to 0.9). Use closer intervals for the deeper parts of the channel.

2. Start at the water's edge and call out the distance first, then the depth, then the velocity. Stand downstream from the current meter in a position that least affects the velocity of the water passing the meter. Hold the rod in a vertical position with the meter directly into the flow. Stand approximately 1 to 3 inches downstream from the tape and at least 18 inches from the meter.
3. To take a reading, the meter must be completely under water, facing into the current, and free of interference. The meter may be adjusted slightly up or downstream to avoid boulders, snags and other obstructions. The note taker will call out the calculated distance interval, which the meter operator may decide to change (e.g., taking readings at closer intervals in deep, high-velocity parts of the channel). Record the actual distance called out by the meter operator as the centerline for the subsection.
 - Take one or two velocity measurements at each subsection.
 - If depth (d) is less than 2.5 feet, measure velocity (\bar{v}) once for each subsection at 0.6 times the total depth (d) measured from the water surface (e.g., if d is 2 feet, measure at 1.2 feet from the water surface, or 0.8 feet above the bottom).
 - If depth (d) is greater than 2.5 feet, measure velocity (\bar{v}) twice, at 0.2 and 0.8 times the total depth (e.g., if d is 3 feet, measure at 0.6 ft. and 2.4 ft. from the water surface). The average of these two readings (+) is the velocity for the subsection.
4. Allow enough time for each reading — a minimum of 40 seconds for most meters. The operator calls out the distance, then the depth, and then the velocity. The note taker repeats

¹ The use of trade and company names is for the benefit of the reader, such use does not constitute an official endorsement or approval of any service or product by the U.S. Department of Agriculture to the exclusion of others that may be suitable.

it back as it is recorded, as a check. Readings from some meters (clicks) must be converted by the note taker, while others read out digitally in feet-per-second. Figure 58 shows the field record of width, depth, and velocity measurements.

- Calculate discharge in the field (specifics in next section). If any section has more than 5% of the total flow, subdivide that section and make more measurements.

Computing Discharge

When the velocity measurement is complete, calculate the total discharge (Q). Determining total discharge accurately is a complex issue, and a variety of methods and equations exist. The mid-section method is currently recommended by the U.S. Geological Survey. (At the risk of offending those with the proper math skills, the method is explained step-by-step.)

The following formula defines the basic method for calculating discharge:

$$Q = \sum (a \bar{V})$$

where

Q is the total discharge, a is the area of a rectangular subsection, the product of width (w) and depth (d) for that subsection, and

\bar{V} is the mean velocity of the current in a subsection.

- Using the mid-section method, compute the area (a_n) of each subsection:

$$a_n = d_n \frac{b(n+1) - b(n-1)}{2}$$

where

b is distance along the tape from initial point. "Lost" discharge in the triangular areas at the edges is assumed negligible.

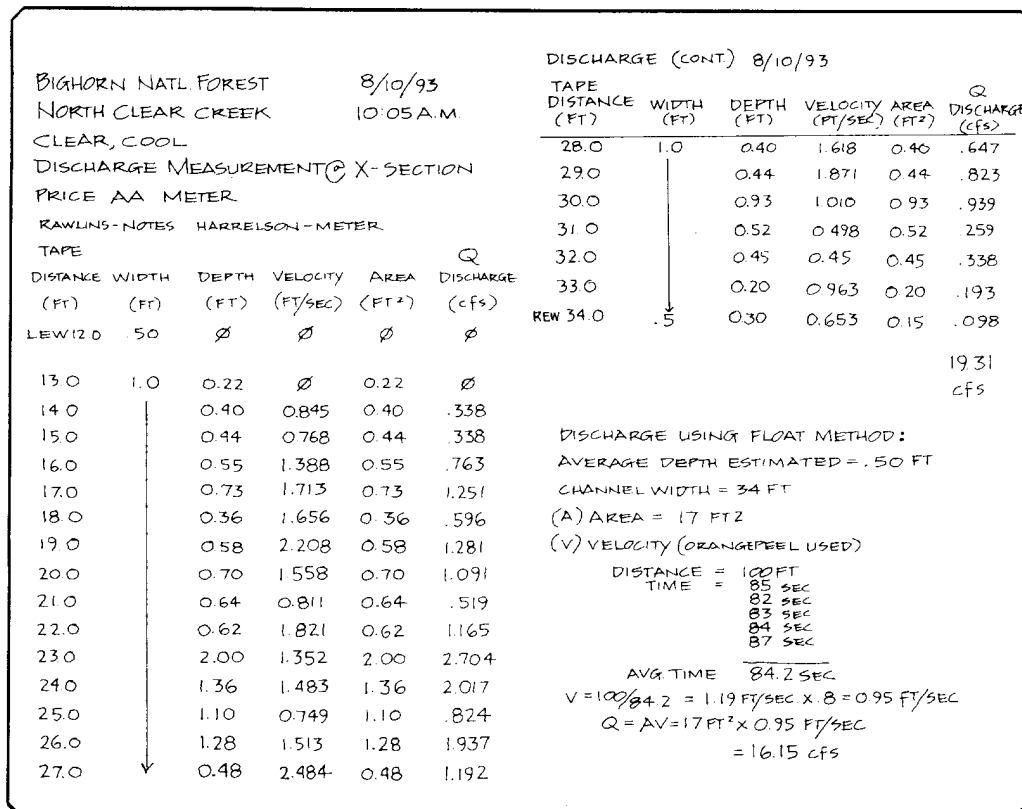

Figure 58. - Field notes of discharge measurement.

2. Next, multiply the subsectional area (a_n) by the mean velocity (\bar{V}_n) for the subsection to get the subsection discharge (Q_n). If only one velocity measurement was taken at 0.6 depth, it is the mean velocity (\bar{V}_n). If two measurements (\bar{v}_1 and \bar{v}_2) were taken at 0.2 and 0.8 depth, compute the mean value as below:

$$\bar{V}_n = \frac{\bar{v}_1 + \bar{v}_2}{2}$$

3. To compute the discharge for each subsection, use the equation:

$$Q_n = a_n \bar{V}_n$$

where

Q_n = discharge for subsection n,
 a_n = area of subsection n, and
 \bar{V}_n = mean velocity for subsection n.

The calculation repeats this process for each subsection, as shown below:

$$Q_1 = a_1 \bar{V}_1, Q_2 = a_2 \bar{V}_2, Q_3 = a_3 \bar{V}_3, \\ Q_4 = a_4 \bar{V}_4, \text{ and so on...}$$

4. The subsection products are then added to get total discharge (Q):

$$Q = Q_1 + Q_2 + Q_3 + Q_4 + Q_5 \\ \text{and so on...}$$

Thus, total discharge (Q) equals the sum of all discharges $\sum (a \bar{V})$, as stated earlier in the basic equation:

$$Q = \sum (a \bar{V}).$$

If you have any questions about this computation, draw a hypothetical cross-section, assign current velocities (from 0 to 5 feet per second) to each vertical, and work out a sample discharge before going to the field. Field crew members should understand this procedure and be able to compute sample discharges before field work begins.

FLOAT METHOD FOR CURRENT VELOCITY

A float measurement is a good, simple way to estimate discharge provided velocity has been previously metered and cross-sectional area calculated.

Even where observers are not highly skilled or do not have a current meter available, readings of gage height and float velocity can provide a valuable record of stream flow. Personnel at guard stations, hosted campgrounds, summer camps, and other sites can collect regular stream flow measurements.

Equipment for float method measurement is simple: a measuring tape, a timer (a digital watch), and 5-10 floats. For floats, use orange peel, a water-soaked block of wood, or other natural material that sinks at least halfway into the water, is visible from shore, won't be moved by wind, and is expendable and non-polluting (e.g., not ping-pong balls and plastic jugs).

Float Method Procedure

1. Measure and mark two points, at least two to three channel widths apart, at the channel cross-section. If stationing stakes are still in place, one or two may be left in the ground to serve as markers.
2. Two observers are best. One tosses the float into the channel above the marker and calls out when it crosses the upstream point. Toss each float a different distance from the bank to get a rough average of velocities.

3. The downstream observer starts the timer, sighting across the stream from the lower point. When the float passes it, stop the watch and record the time. Repeat the procedure 5 to 10 times. Average the values to get the mean surface velocity, and then multiply it by a velocity adjustment coefficient of 0.85 to calculate the mean velocity of the entire cross-section. (This coefficient can range from 0.8 to 0.95 depending on the roughness of the channel.)
4. Using the previously measured cross-sectional area, multiply velocity times area to find discharge ($Q = VA$). Record it on a data sheet with date, time, etc.

11. Bed and Bank Material Characterization

The composition of the stream bed and banks is an important facet of stream character, influencing channel form and hydraulics, erosion rates, sediment supply, and other parameters. Each permanent reference site includes a basic characterization of bed and bank material. For studies of fish habitat, riparian ecosystems or stream hydraulics, the characterization of substrates and bank materials may require greater detail than can be covered in this manual.

CHARACTERIZING STREAM BEDS

The composition of the stream bed (substrate) is an important factor in how streams behave. Observations tell us that steep mountain streams with beds of boulders and cobbles act differently from low-gradient streams with beds of sand or silt. You can document this difference with a quantitative description of the bed material, called a pebble count.

The most efficient basic technique is the Wolman Pebble Count (1954). This requires an observer with a metric ruler who wades the stream and a note taker who wades or remains on the bank with the field book.

Particles are tallied by using Wentworth size classes in which the size doubles with each class (2, 4, 8, 16, 32, etc.) or smaller class intervals based on 1/2 phi values (4, 5, 6, 8, 11, 16, 22, 32, etc.).

The latter classes are generally used when detailed particle size data are needed.

Table 2 shows size classes and size ranges. Particles smaller than 2mm in size are placed in a class defined as "<2mm."

Pebble counts can be made using grids, transects, or a random step-toe procedure. A step-toe procedure is used here.

Pebble Count Procedure

1. Select a reach on or near the cross-section and indicate it on your site map. For stream characterization, sample pools and riffles in the same proportions as they occur in the study reach. For other purposes, it may be

Table 2. - Pebble count size classes.

Size Class	Size Range (mm)
Sand	<2
Very Fine Gravel	2-4
Fine Gravel	4-6
Fine Gravel	6-8
Medium Gravel	8-11
Medium Gravel	11-16
Coarse Gravel	16-22
Coarse Gravel	22-32
Very Coarse Gravel	32-45
Very Coarse Gravel	45-64
Small Cobble	64-90
Medium Cobble	90-128
Large Cobble	128-180
Very Large Cobble	180-256
Small Boulder	256-512
Medium Boulder	512-1024
Large Boulder	1024-2048
Very Large Boulder	2048-4096

appropriate to sample pools and riffles separately. Measure a minimum of 100 particles to obtain a valid count. Use a tally sheet to record the count.

2. Start the transect at a randomly selected point (perhaps by tossing a pebble) at one of the bankfull elevations (not necessarily the present water level). Averting your gaze, pick up the first particle touched by the tip of your index finger at the toe of your wader (fig. 59).
3. Measure the intermediate axis (neither the longest nor shortest of the three mutually perpendicular sides of each particle picked up) (fig. 60 and 61). Measure embedded particles or those too large to be moved in place. For these, measure the smaller of the two exposed axes. Call out the measurement. The note taker tallies it by size class and repeats it back for confirmation.



Figure 59. - Picking up pebble.



Figure 61. - Measuring intermediate axes.

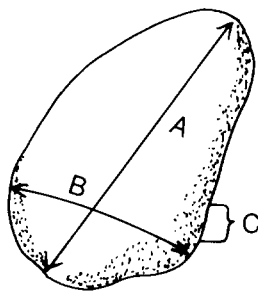

- A = LONGEST AXIS (LENGTH)
- B = INTERMEDIATE AXIS (WIDTH)
- C = SHORTEST AXIS (THICKNESS)

Figure 60. - Intermediate axes of pebble.

4. Take one step across the channel in the direction of the opposite bank and repeat the process, continuing to

pick up particles until you have the requisite number (100 or more) of measurements. The note taker keeps count. Traverse across the stream perpendicular to the flow. Continue your traverse of the cross-section until you reach an indicator of bankfull stage on the opposite bank so that all areas between the bankfull elevations are representatively sampled. You may have to duck under bank-top vegetation or reach down through brush to get an accurate count. Move upstream or downstream randomly or at a predetermined distance and make additional transects to sample a total of at least 100 particles.

After counts and tallies are complete, plot the data by size class and frequency (fig. 62).

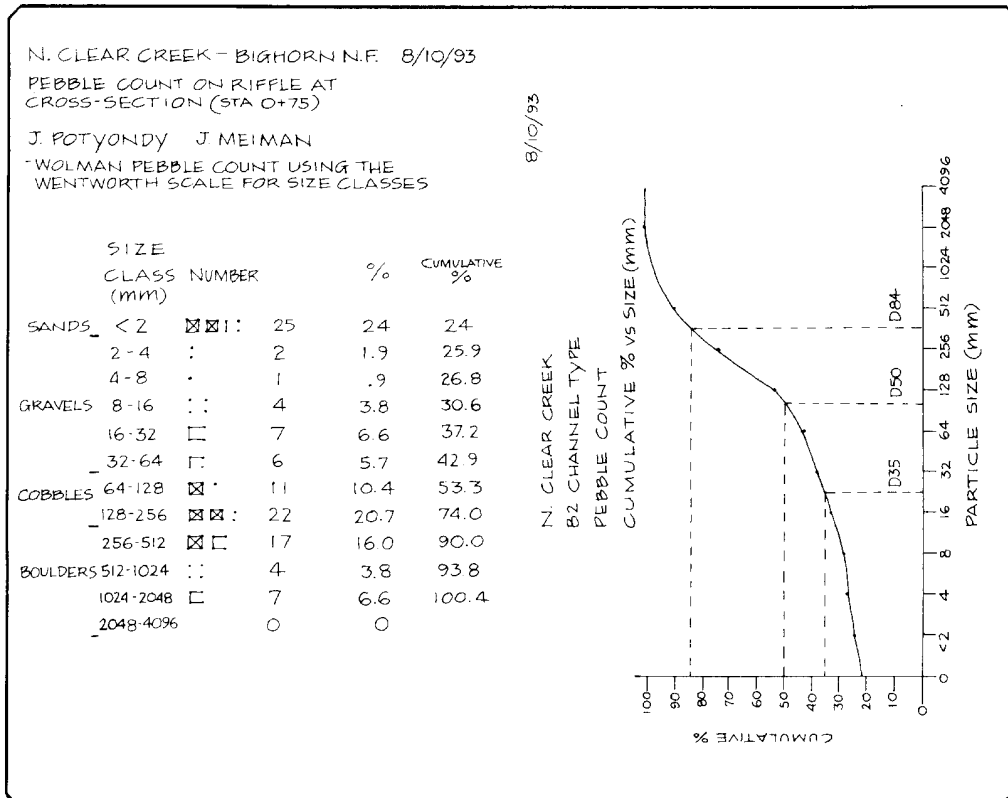

Figure 62. - Field plot of pebble count.

Scour Chains

Scour chains may be used to measure the aggradation or degradation of the stream bed. Place a standard length of chain or abrasion-resistant cord vertically into the bed material with the lower end anchored to a horizontal pin below the estimated extent of scouring. The loose end should drape over the bed surface (fig. 63).

Install scour chains at a surveyed cross-section, at intervals according to channel width and complexity (generally 5 to 10 chains per cross-section). Measure and record (along with a tape measurement of the length of chain left exposed, if any) the elevation of the lower end of each chain and the present elevation of the bed material. Excavate chains after peak flow events and repeat measurement of the chains along with a survey of the cross-section. A kink or bend in a buried chain indicates scouring and reburial. (For more information see Gordon 1992; Lisle and Eads 1991.)

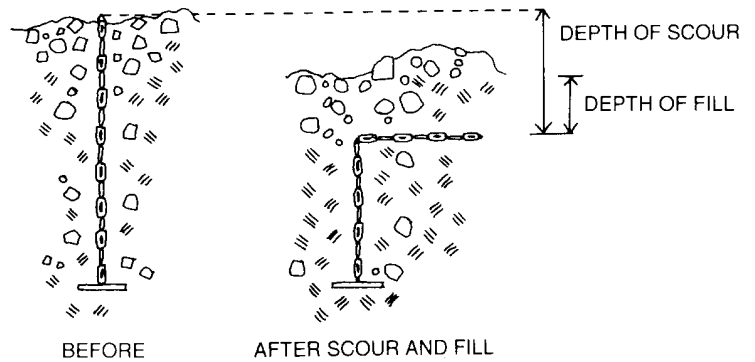

Figure 63. - Scour chains and placement.

CHARACTERIZING STREAM BANKS

Describing the composition and condition of stream banks is an important aspect of monitoring and is best done when streams are at low stage and most of the bank is visible. Describe both banks at the cross-section and other sites as necessary for study purposes. Measure distances upstream or downstream from the cross-section and note sites on your map.

Three techniques for characterizing banks include photographs and notes, sieve analysis, and erosion pins.

Photographs and Notes

For basic documentation, photograph the bank from the channel centerline, at the cross-section. In the field book, record each photograph and write a brief, top-down description of the angle, structure, and bank material. Pebble count transects can be laid out along stream banks and tallied in the conventional way. This technique is generally only usable in coarse bank materials. Detailed description of soils should follow methods in U. S. Soil Conservation Service, *Soil Survey Handbook* (1982) and *Soil Taxonomy* (1975) or subsequent versions. An example of simple notes is given below:

LB: Top, 2.1 ft., willow, eroding soil, a) 4" grey sand; b) 3" mixed red sand and 2-4mm gravel; c) 0.5" black silt or ash; d) 6" 2-4mm gravel. **LEW** 2.3 FT.

RB: **REW** 18.4 ft., 4-8mm gravel grading to 2-4mm gravel; 22.6 ft.- red sand with organic debris; 24.3 ft.- 170°, alternating thin layers of red sand and black silt with new growth *Scirpus spp.*

Reference color slides to the field book volume and page where the bank is described. Consider use of stereo photography for greater analytical detail (Brewer and Berrier 1984).

Sieve Analysis

If detailed information on bank material is needed, take standard 25 lb. soil samples, and sieve and weigh fractions according to methods in U. S. Soil Conservation Service, *Soil Survey*

Handbook (1982). Most Forests have one or more soil scientists to provide help with specifics. Transfer the resulting data to the field book and/or place it in the permanent file for the site.

Bank Erosion Pins

Repeated cross-section and longitudinal profile surveys will measure erosive or depositional changes in banks, but smaller changes may be registered by using bank erosion pins. These are fine metal rods (1/16" - 1/8" x 4" - 12" long) inserted horizontally at regular intervals into a stream bank, leaving a standard length exposed. Measure the elevation of each pin with a rod and level.

On successive visits to the site, measure the exposure of each pin and record it, then drive exposed pins into the bank. If pins are entirely lost, make a note and insert another pin at the same elevation. Figure 64 shows a diagram of erosion pins and placement.

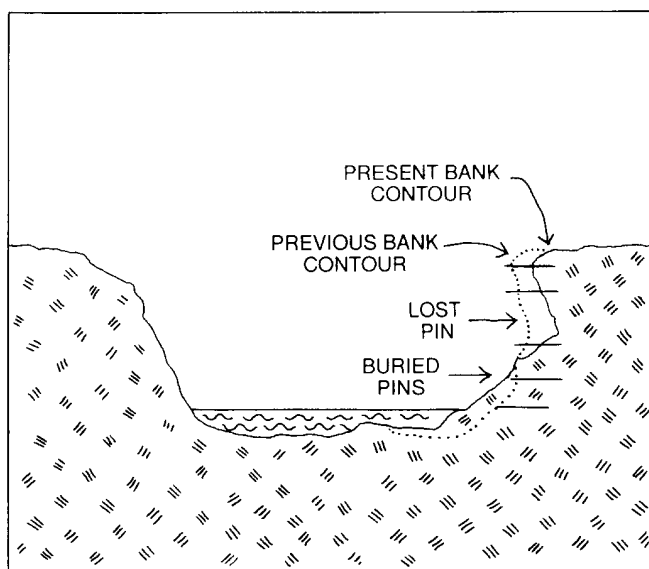

Figure 64. - Bank erosion pins.

12. Permanent Files

Permanent reference sites track changes in stream channels over long periods of time. The measurements must be both available and usable, despite transfers and other changes in agency staff and organization. Besides local uses for this data, it may be included in regional or national databases, conferring a sort of hydrologic immortality on the collector.

Orderly, consistent methods of recording data make the task easier at each level: in the field notebook, in permanent records, in computer databases, and over large networks like Vigil.

ELECTRONIC DATA COLLECTION AND STORAGE

As electronic data loggers and Geographic Information Systems (GIS) or Global Positioning System (GPS) remote loggers become increasingly available, they may replace the sturdy orange field book, but the principle is the same: data records should be orderly, consistent, and clear to allow broad use and replication. Use consistent file names, with the same system year-to-year. Always back up computer files on a removable medium (floppy disk, tape cartridge, etc.) and store two copies of the back-up in different locations (e.g., one at the District and one in the Forest Hydrologist's office).

FILE MANAGEMENT

Active management of files makes stream data available for long-term use. Use present filing systems (such as Forest Service watershed case folders; See FSH 6209.11 "Records Management Handbook") to permanently store data on a watershed basis. If cooperation with other agencies such as the U.S. Geological Survey is planned, agree upon common file formats.

Multiple hard copies are a good idea: one for the district file and one for the Forest Hydrologist. Never take original records for extended use elsewhere: use copies. Place duplicates in three-ring binders for use at meetings, in the field, etc.

DATA NETWORKS

Attempts to collect and correlate stream data on levels broader than basin or state boundaries are underway. One such effort is the Vigil network, proposed by Luna Leopold of the U.S. Geological Survey in 1962 and adopted by UNESCO in 1965. Vigil sites are chosen for observation of basic geomorphic processes over extended periods. The Vigil network is an ideal place to permanently store reference site data. Vigil site files should include

- location by USGS map township and range, with latitude and longitude;
- a tabulated road log of distances from permanently identifiable features;
- a legible copy of a topographic map or a plane-table or sketch map of the site (sized to fit in a file folder) showing pertinent features and permanent benchmarks found or installed;
- a physical description of the geology, soils, vegetation, climate, and topography; features that lend significance to the site should be described (such as "only glaciated reach in Madison Limestone for the Central Rockies").
- photographs should be identified by date and position of camera, with the location of negatives noted;
- the data sheets that show the benchmark elevations and the initial survey data (units may be either metric or English, but should be consistent throughout a file); and
- references for methods, site information, and supporting information.

Records submitted to the Vigil network should be as complete as possible, but not all the categories of information listed on the card are required in order to submit a new report.

Figure 65 shows a sample index card for the Vigil network, which should accompany each report. Appendix B contains a sample Vigil site record.

For further information, consult *The Vigil Network: Preservation and Access of Data* by Emmett and Hadley (1968).

VIGIL NETWORK SITE
INDEX CARD

Card No. _____
Type _____
Date Dec. 1, 1967

Site name Last Day Gully Location Hudson, Wyoming, U.S.A.

U.S. Geological Survey

Principal site investigator William W. Emmett Address Washington, D.C. 20242

Purposes (check; if more than one, number in order of importance):

Channel change 1 Erosion 2 Sedimentation 3 Mass movement 4 Vegetation 5

Number and type of observations (if applicable, write number of such installations):

Stream channels

Channel cross sections 16

Scour chains 3

Bed profile 1

Water-surface profile _____

Discharge:

Crest-stage gage 1

Gaging station _____

Suspended sediment _____

Chemical _____

Other (specify) _____

Vegetation

Transects _____

Quadrats 1

Grasses 1, shrubs 1,
trees _____

Tree-ring data _____

Other (specify) _____

Hillslopes

Erosion stakes 2 lines

Mass-movement pins 2 lines

Painted rock lines _____

Cliff-recession markers _____

Profiles _____

Water runoff _____

Other (specify) _____

Other

Reservoir sedimentation _____

Rain gage _____

Soil chemistry _____

Soil moisture _____

Particle size:

Streambed 4

Bank _____

Hillslope _____

Pollen _____

Other (specify) _____

*Further data**

If a basin, drainage area 55 acres

If a plot _____

Elev 5,150 feet

Ann. precipitation 10 inches

Relief 142 feet

Geology:

Vegetation:

Hydrology:

Photography: Ground and
low-altitude aerial.

Other:

* Include units of measurement, metric
or English

Figure 65. - Index card for Vigil network.

References

- Brewer, L. and D. Berrier, 1984. Photographic techniques for monitoring resource change at back country sites. Gen. Tech. Rep. NE-86, USDA. Forest Service, Northeastern Forest Exp. Station.
- Dunne, T. and L. Leopold, 1978. Water in Environmental Planning. W. H. Freeman, New York, 818 pp.
- Emmett, W. W., 1975. Hydrologic evaluation of the upper Salmon River area, Idaho. U.S. Geological Survey Professional Paper 870-A, U.S. Govt. Printing Office, Washington, D.C.
- Emmett, W. W. and R. Hadley, 1968. The Vigil Network: preservation and access of data. U.S. Geological Survey Circular 460-C, U.S. Dept. Interior, Govt. Printing Off., Washington, D.C.
- Langbein, W. B. and K. Iseri, 1960. General introduction and hydrologic definitions. U.S. Geological Survey Water-Supply Paper 1541-A. U.S. Govt. Printing Office, Washington, D.C.
- Leopold, L. B., 1994 (in press). A View of the River. Harvard Univ. Press. Cambridge, MA.
- Leopold, L. B., M. Wolman, and J. Miller, 1964. Fluvial Processes in Geomorphology. W. H. Freeman, San Francisco, CA, 522 pp.
- Lisle, T. E. and R. Eads, 1991. Methods to measure sedimentation of spawning gravels. Research Note PSW-411. USDA. Forest Service, Pacific Southwest Research Station, Berkeley, CA.
- Rosgen, D. L., 1994 (in press). A classification of natural rivers. Submitted to Catena. Catena, Elsevier Publications, Amsterdam.
- U.S. Geological Survey, 1977. National handbook of recommended methods for water data acquisition. U.S. Govt. Printing Office, Washington, D.C.
- U.S. Soil Conservation Service, 1975. Soil Taxonomy. Agricultural Handbook No. 436. U.S. Govt. Printing Office., Washington, D.C.
- U.S. Soil Conservation Service, 1982. Soil Survey Handbook. U.S. Govt. Printing Office, Washington, D.C.
- USDA Forest Service. Records Management Handbook, FSH 6209.11, Chapter 40.

Appendix A. Equipment List

- aluminum nursery tags or rebar caps
- background publications
- batteries
- calculator (inexpensive, solar powered)
- camera, 35mm with 50mm lens
- canvas tote bag
- clippers (8" hand pruners)
- compass
- field note books
- field instructions (e.g., this manual)
- flagging and/or flag pins
- flashlight
- gloves
- hammer for stakes
- insect repellent
- maps (USGS and country)
- name board (for photographs)
- paint (high visibility orange)
- pencils and leads
- pliers with wire cutters
- rod level
- ruler (mm)
- permanent marking pen
- stakes with spoonbill clamp and tension spring

- sun screen
- stopwatch
- tapes (100' and 300' plastic coated; graduated to 0.1')
- tire patch kit
- wire (18 gage galvanized)
- zip lock bags (gallon size)

CREW VEHICLE

- backpack
- brush cutter or bow saw
- field brief case
- first aid kit
- level and tripod
- post driver or sledge hammer
- top setting rod
- rain tarp
- safety rope (100')
- shovel (long handle and pointed)
- survey rod (14' extended, fiberglass preferred)
- current meter
- waders

Appendix B. Sample Vigil Site Record

From appendix in *The Vigil Network: Preservation and Access of Data* by W.W. Emmett and R.F. Hadley, Geological Survey Circular 460-C, 1968. US Geological Survey, Washington, DC 20242.

Submitted by William W. Emmett and Luna B. Leopold*

Last Day Gully is an example of a small ephemeral basin which has alternately degraded and aggraded in post-Pleistocene time, presumably in response to changes in climate. It terminates in a small alluvial fan on top of a 15-foot alluvial terrace in the valley of the Popo Agie River. The planimetric map of figure 1 illustrates the general configuration of Last Day Gully.

Because similar gullies in small basins are common and because their visual aspect alone does not indicate whether in the present climate these gullies are aggrading, stable, or degrading, this one was chosen for long-term observation as part of the Vigil Network.

This site is an ephemeral wash, or gully, about 1 mile northeast of Hudson, WY, NW 1/4 sec. 5, T. 2 S., R. 3 E. (lat 42° 55'33" N., long 108° 34;19" W.). It is included on the topographic maps published by the US Geological Survey entitled "Hudson, Wyo.," scale 1:24,000 and "Lander, Wyo.," scale 1:250,000 (parts of both appear in this folder, figs. 2-3). The main channel extends about 3,400 feet from the watershed divide to its end. The gully terminates in a semicircular alluvial fan. The gully bed is sand silt and nearly free of vegetation. Vegetation adjacent to the channel consists of a mixture of low shrubs and grasses. Predominant shrubs are sagebrush (*Artemisia tridentata* Nutt.) and cactuses (*Opuntia* spp.). Grasses generally belong to the grama species (*Bouteloua*). Total vegetation cover varies but averages about 30-35 percent. The total area within the watershed is about 55 acres. The average elevation is 5,150 feet above sea level, and the relief between the watershed divide and the alluvial fan is 142 feet. Precipitation averages about 10 inches per year.

To reach the site of Last Day Gully, one may start at the center of the village of Hudson, Wyo. (see Hudson, Wyo, 1:24,000 topographic map, fig 2), proceed east on State Highway 789 for three-quarters of a mile, and then turn north onto an unimproved side road. This road becomes a one-lane steel bridge crossing the Popo Agie River 200 yards from the junction with State Highway 789. After crossing the bridge one proceeds about 700 yards, leaves his automobile, and walks westerly along a fence, bearing N. 20 E. At a distance of 400 feet along the fence is the mouth of Last Day Gully, where the channel terminates in a low-angle fan. The alluvial fan and fence line are indicated in the upper left of the enclosed planimetric map of Last Day Gully (fig. 1). The permanent reference points along the stream, consisting of

* Note: Due to space limitations, field data tables 1-18 from original source are not included in this Appendix.

1/2-inch diameter steel rods driven in the ground and protruding about 6 inches above the ground surface, are noted on the map by a small solid dot at each end of the lines marking the cross sections.

The principal measurements consist of 16 cross-channel land-surface profiles surveyed at specified locations and are also shown on the planimetric map (fig. 1). At the time of preparation of this file, four field surveys had been made: August 6-8, 1962, June 9-10, 1963, July 26, 1965, and June 18, 1966. Elevations from these surveys are listed in the next series of tables (tables 2-17). In addition to having bench marks, two of the cross sections were instrumented with 10-inch-long steel pins driven into the ground at given locations (sections A-B and E-D). Values of erosion can be determined accurately at these pins and are given in the tables for sections A-B and E-D in lieu of elevations from annual resurveys. It is emphasized that these 10-inch-long pins will not maintain their permanence if left unattended during periods of erosion that cause degradation exceeding the length of the pins.

In addition, a longitudinal profile of the main channel bed was surveyed over a distance of 3,575 feet beginning 150 feet below the fence line near the junction of the channel mouth and its alluvial fan. These data are found in table 18 of this file.

Other observations are being made, including depth of channel scour, height of floodflow, retreat of channel headcuts, and mass movement in slopes. Channel scour is measured by scour chains at stations 3+00, 6+00, and 9+00. The scour-fill record is incomplete because of the annual basis for resurvey. Scour, followed by slightly greater fill, is responsible for an overall aggradation of the channel bed. Height of floodflow is recorded on a crest-stage gage at station 1+50. Mass movement is being observed on two lines of pins installed near BM-D. These are indicated on the planimetric map (fig. 1) enclosed in this file. Annual surveys from the time of their installation in 1963 to 1967 show no significant downhill movement of the pins.

The file of original field data includes a planimetric map (simplified reproduction, fig. 1) made by planetable survey of the channel in 1962 and black-and-white and color photographs taken from 1962 to 1966. Film negatives and the original planetable survey are on file with William W. Emmett, US Geological Survey, Washington, DC 20242, USA. Prints are available for the cost of reproduction.

The following publications are partly devoted to information about Last Day Gully:

Emmett, W. W. 1965, The Vigil Network: Methods of measurement and a sampling of data collected: symposium of Budapest, Internat. Assoc. Sci. Hydrology Pub. 66, p. 89-106.

Leopold, L. B., and Emmett, W. W., 1965, Vigil Network sites: A sample of data for permanent filing: Internat. Assoc. Sci. Hydrology Bull., v. 10, no. 3, p. 12-21.

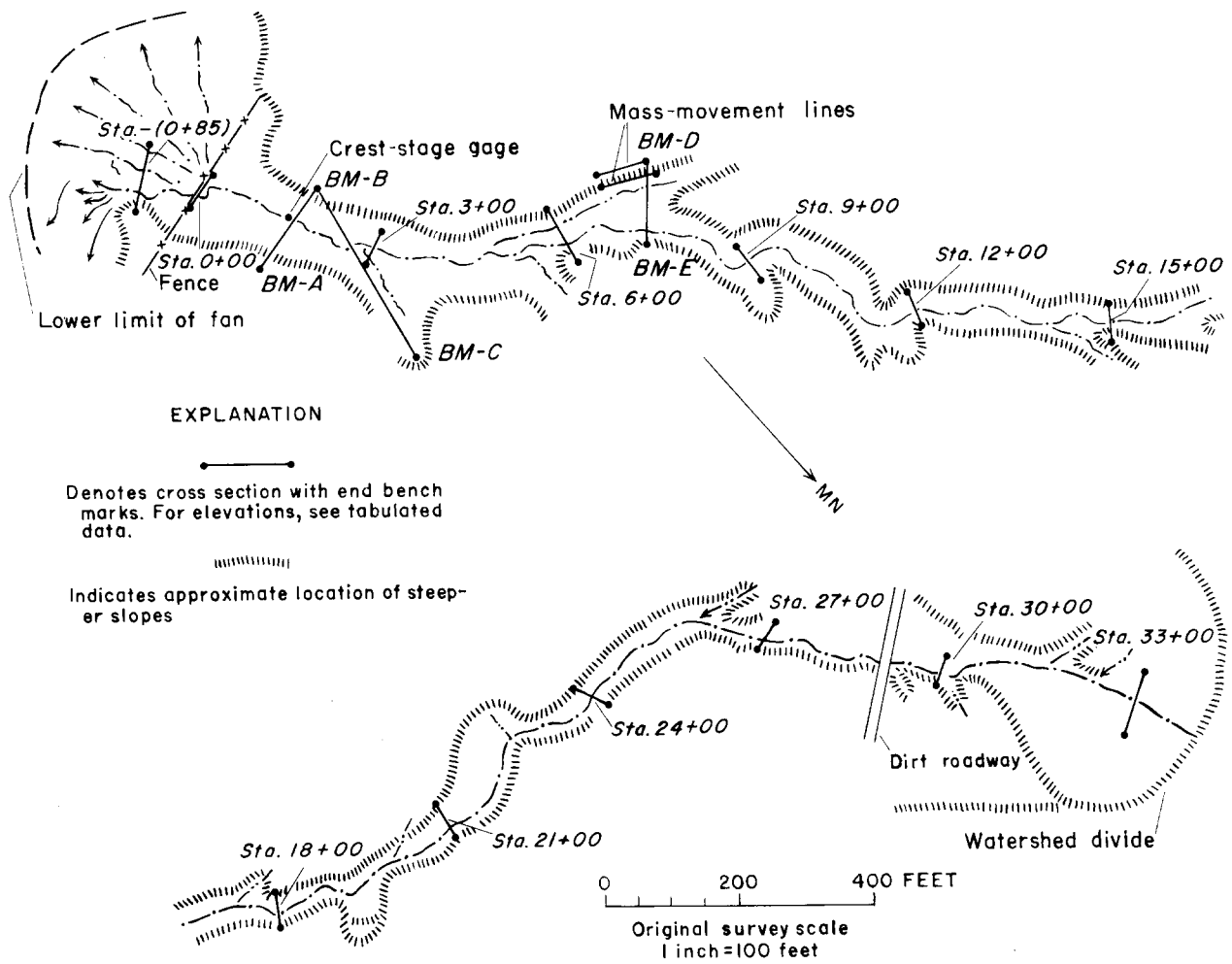

Figure 1. - Planimetric map of Last Day Gully, Wyo.

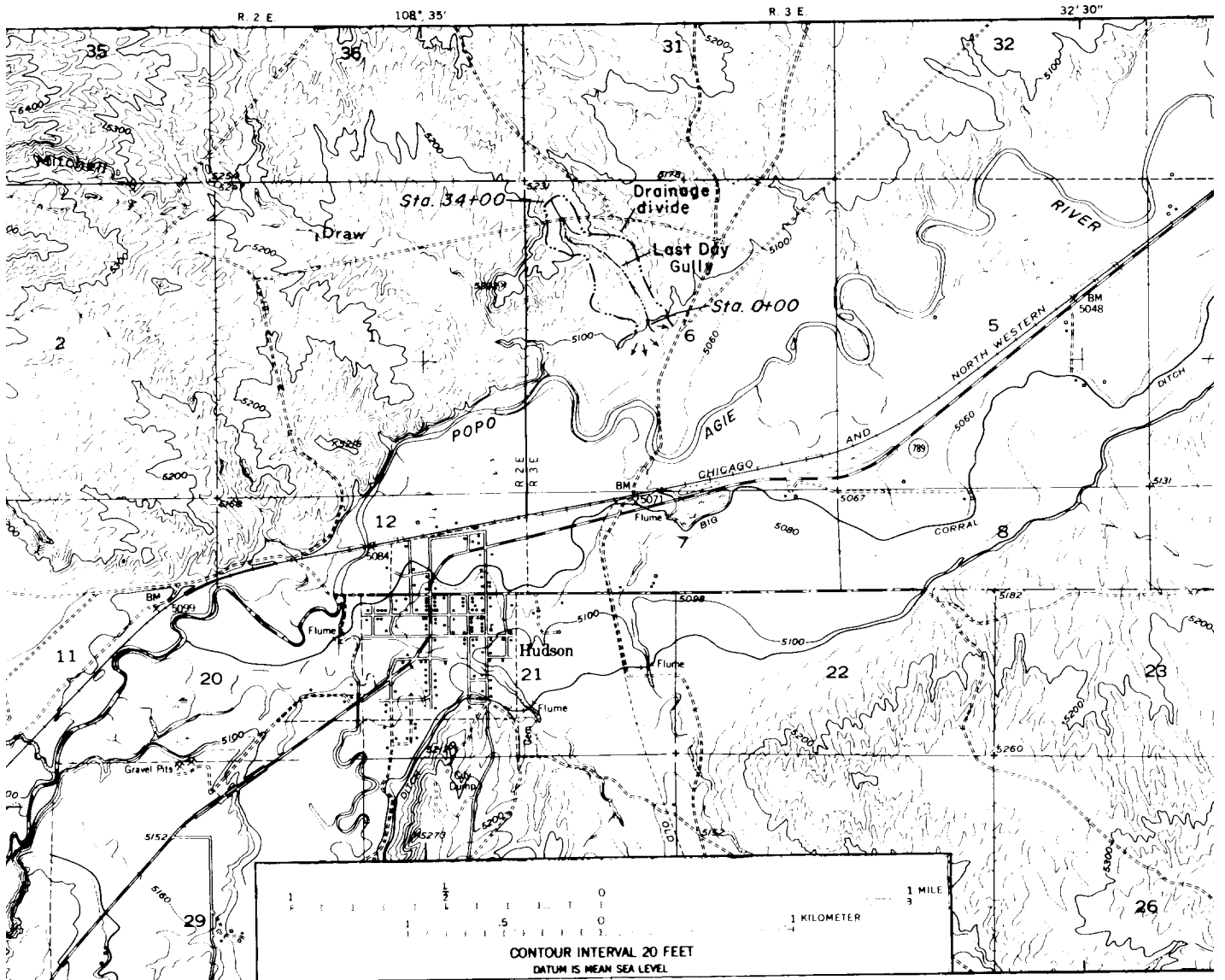

Figure 2. - Part of Hudson, Wyo., 1:24,000 U.S. Geological Survey topographic quadrangle map, showing location of Last Day Gully.

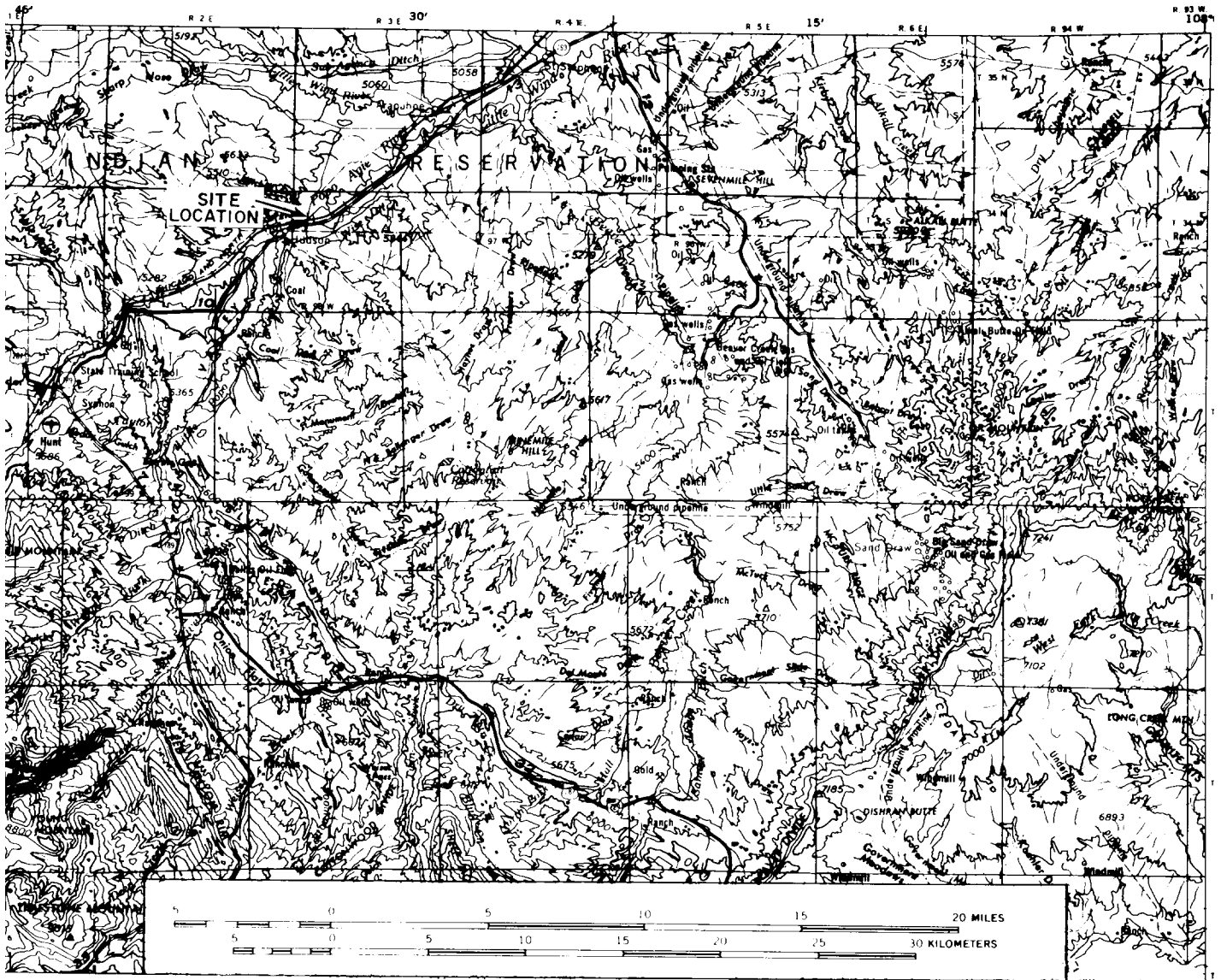

Figure 3. - Part of Lander, Wyo., 1:250,000 U.S. Geological Survey topographic map, showing location of Last Day Gully.

Acknowledgments

The authors thank the Stream Systems Technology Center of the Rocky Mountain Station, especially hydrologist Larry Schmidt, for supporting and guiding the work on this document.

Valuable help in the field and advice on technical matters was graciously extended by Dr. William W. Emmett, Research Hydrologist, U. S. Geological Survey Water Resources Division.

Further thanks are due to the Bighorn National Forest and the Buffalo Ranger District for their facilities and assistance with this project.

David L. Rosgen provided figures, definitions, and keys on stream classification from *A Classification of Natural Rivers* for which we are grateful.

Special thanks to Hannah Hinchman for drafting the figures and field book notes in this paper.

We are grateful to Dr. Luna B. Leopold, former Chief Hydrologist of the U.S. Geological Survey and Professor Emeritus of the University of California, for the quality of his work and his inspiring scientific integrity. Dr. Leopold has done channel surveys throughout much of the United States and has long encouraged Forest Service hydrologists to conduct these surveys as one aspect of stream monitoring. Many of the techniques written and illustrated in this document were originally presented in an abbreviated manner in the book *Water in Environmental Planning* by Thomas Dunne and Luna Leopold. Our attempt here is to fill in the details so that the monitoring envisioned by Dr. Leopold for the National Forests will become a reality.

USDA policy prohibits discrimination because of race, color, national origin, sex, age, religion, or handicapping condition. Any person who believes he or she has been discriminated against in any USDA-related activity should immediately contact the Secretary of Agriculture, Washington, DC 20250.

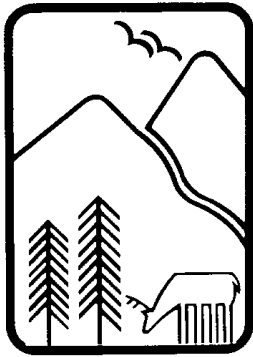

Rocky
Mountains

U.S. Department of Agriculture
Forest Service

Rocky Mountain Forest and Range Experiment Station

The Rocky Mountain Station is one of eight regional experiment stations, plus the Forest Products Laboratory and the Washington Office Staff, that make up the Forest Service research organization.

RESEARCH FOCUS

Research programs at the Rocky Mountain Station are coordinated with area universities and with other institutions. Many studies are conducted on a cooperative basis to accelerate solutions to problems involving range, water, wildlife and fish habitat, human and community development, timber, recreation, protection, and multiresource evaluation.

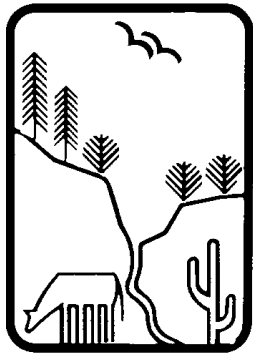

Southwest

RESEARCH LOCATIONS

Research Work Units of the Rocky Mountain Station are operated in cooperation with universities in the following cities:

Albuquerque, New Mexico
Flagstaff, Arizona
Fort Collins, Colorado*
Laramie, Wyoming
Lincoln, Nebraska
Rapid City, South Dakota



Great
Plains

*Station Headquarters: 240 W. Prospect Rd., Fort Collins, CO 80526